



Flexible & reliable

WT1800E Series High performance Power Analyzers

Precision Making

Bulletin WT1800E-01EN

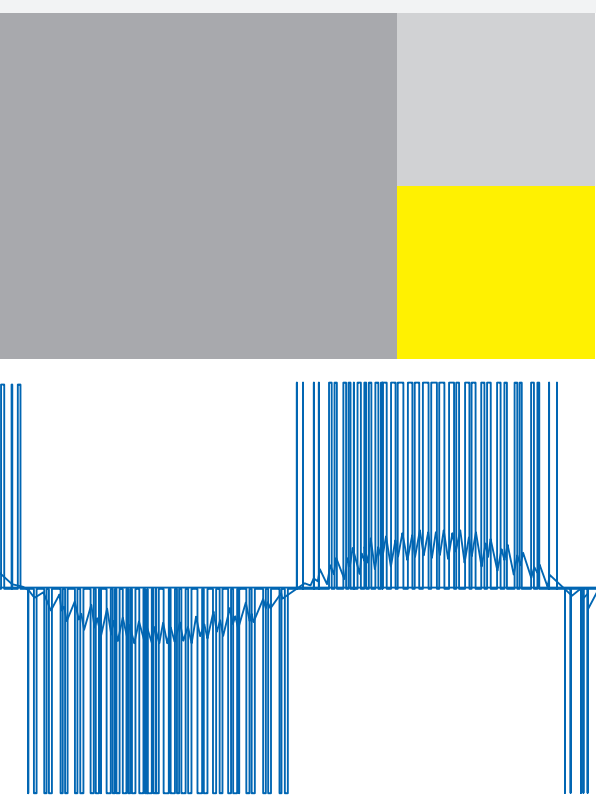

To curb global warming, greater efforts are being made to generate and use power more efficiently. The use of renewable energy sources like solar and wind power is growing and there is accelerated development of environmentally-friendly cars and energy-efficient machines and devices.

Developing these technologies requires accurate measurements to validate even the smallest changes in energy consumption. In the WT1800E high performance power analyzer, engineers have the ideal tool to accurately measure power, its quality and efficiency.

Whether analyzing multiphase inputs during motor and drive design or meeting the stringent efficiency standards of photovoltaic inverters, the WT1800E provides the versatility to help engineers bring their product concepts successfully to market

The WT1800E delivers:

Accuracy – The WT1800E is the only instrument in its class that guarantees a power accuracy of 0.05% of reading plus 0.05% of range and is capable of harmonics analysis up to the 500th order of a 50/60 Hz fundamental frequency.

Reliability – Measurements need to be repeatable as well as accurate. The stability of the WT1800E ensures that precision measurements can be made today and over the long term.

Flexibility – With up to 6 input channels, a wide range of display and analysis features, and PC connectivity, the WT1800E is the measurement solution for a broad range of power efficiency and harmonic analysis requirements.



Features and benefits

6 inputs on a high resolution display

Make simultaneous measurements on up to 6 inputs at 2 MS/s (16 bits). The high resolution 8.4 inch XGA display of the WT1800E allows split screen viewing of up to 6 waveforms and can display up to 12 pages of diverse measurement parameters making it ideal for efficiency tests of inverter driven motors, renewable energy technologies and traction applications like pumps, fans and hybrid/electric vehicles. The unit can also display measurements in vector format or trending in time.



Guaranteed accuracy across a wide range

Measure accurately at a wide range of voltage, current and frequency conditions. The basic power accuracy of the WT1800E is guaranteed between 1% to 110% of the selected voltage and current range. This equates to voltages from 15 mV to 1100 Vrms and currents from 0.1 mA to 5.5 Arms (for a 5 A input element) and 10 mA to 55 Arms (for a 50 A input element). The unit is also accurate during large phase shifts and high frequencies thanks to the minimized influence of the low power factor error ($\pm 0.07\%$ of apparent power).

Range configuration

Track signal changes faster by eliminating unnecessary range changes. The WT1800E's range configuration function allows users to select input ranges based on their specific use cases so that optimal range settings are achieved quicker. This reduces the time during repetitive production tests, such as setting to OFF, 100 V, OFF and so on, which is performed frequently on the production line.

Harmonic analyses

Analyze harmonics up to the 500th order for a 50/60 Hz fundamental even at a data update interval of 50 milliseconds. The WT1800E features two options for analyzing harmonics in addition to power parameters,

- Harmonic measurement mode (/G5 option) for fundamental wave, harmonic components and total harmonic distortion (THD)
- Dual Harmonic option (/G6 option) for side by side measurement of harmonics on two different sources for example input and output of inverters, variable speed motors, lighting ballasts, UPS, etc.



Power integration and auto ranging

Measure energy bought and sold in grid connections or charged and discharged in batteries. The WT1800E's Power integration function integrates instantaneous values for both positive and negative readings. It also measures total energy (Wh) and current (Ah) when load conditions vary widely like in devices transitioning from standby to operation mode. Should an input signal start to fall out of the expected range, this function can automatically adjust the range while continuing to integrate the measured values.

High speed data capture

The High Speed data capturing function can measure Sigma-Urms, Sigma-Irms and Sigma-P from DC signal and three phase devices every 5 ms when External Synchronization is OFF or, 1 ms to 100 ms when External Synchronization is ON depending on the frequency of the clock signal.

Flexible & automatic data updates

Manually or automatically set measurement intervals. The WT1800E offers 9 data update interval between 50 ms to 20 s but can also follow fluctuating input frequencies by changing the data update rate automatically. This is useful when measuring devices like motors whose input signal frequency varies with RPM.

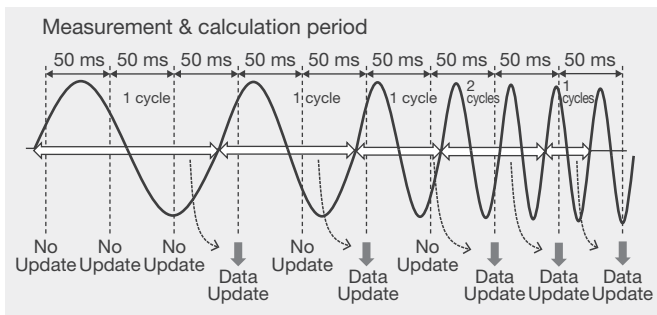

DC power supply for AC/DC current sensors (/PD2 option)

The WT1800E can be equipped with a DC power supply for the CT series of AC/DC current sensors. By using dedicated connection cables and shunt resistors, the WT1800E can measure large currents. Improved S/N ratio and noise immunity is achieved by connecting the sensors in this way.

*/EX1 to /EX6 options must be installed in the WT1800E to be able to use the Shunt Resistor Box.

Motor evaluation function

Measure more than just electrical parameters. The motor evaluation function enables measurement of rotation speed and direction, torque, mechanical power, synchronous speed, slip, electrical angle, motor efficiency and total system efficiency from the analog or pulse outputs of rotation and torque sensors.

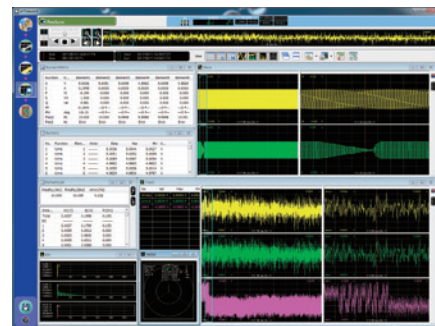

WTViewerE application software

Easily view, control and download measurements from your PC. The WTViewerE is a powerful software connects up to four WT1800Es to a PC via a communications interface making numeric, waveform, trend and harmonic data from the unit easily accessible via PC.

User defined events and computations

The WT1800E's event trigger function allows users to set limits for capture of readings that fall into or out of a specific range of power, current or other parameters. Data that meets the trigger conditions are stored, printed, saved to a USB memory device etc. Users can also define and use up to 20 expressions for custom calculations.

The WT1800E in detail



- 1 External media slot
- 2 Element setting
- 3 U/I range display
- 4 Display settings
- 5 Measurement item selection
- 6 Integration settings
- 7 Data saving
- 8 Built-in printer (/B5 Option)
- 9 Current Sensor Power (/PD2 Option)



- 1 Voltage input terminals
- 2 Current input terminals
- 3 GP-IB port
- 4 BNC connector for two-system synchronized measurement
- 5 Ethernet port (1000BASE-T/100BASE-TX)
- 6 USB port (PC)
- 7 External current sensor input terminals (/EX Option)
- 8 Torque and speed input terminals (/MTR Option)
- 9 D/A output (/DA Option)
- 10 RGB port (/V1 Option)

Two types of input element

Basic Power Accuracy: $\pm(0.05\%$ of reading + 0.05% of range)^{*1}

Measurement Bandwidth: DC, 0.1 Hz to 1 MHz

Low Power Factor Error: Power factor influence when $\cos\phi = 0$
 0.07% of S
 S is reading value of apparent power
 ϕ is phase angle between voltage and current

Temperature range: $23 \pm 5^\circ\text{C}$

Current Range

- Direct Input: 1/2/5/10/20/50 A^{*2}
 10/20/50/100/200/500 mA, 1/2/5 A^{*2}
 (50 A and 5 A input element can be installed together)

- External Input: 50/100/200/500 mV, 1/2/5/10 V^{*2}

Voltage Range: 1.5/3/6/10/15/30/60/100/150/300/600/1000 V^{*2}

Effective input range: 1% to 110%

Data Update Interval: 50 ms to 20 s or Auto

*1 Please refer to "specifications" in detail

*2 Voltage range and current range are for crest factor 3

5 A input element

50 A input element



Both 5 A and 50 A input elements can be installed in a single unit. This enables engineers to use a single WT1800E for multiple applications such as standby power measurement and the evaluation of various operating modes of the device under test.

Example of basic characteristics showing the WT1800E's high precision and excellent stability

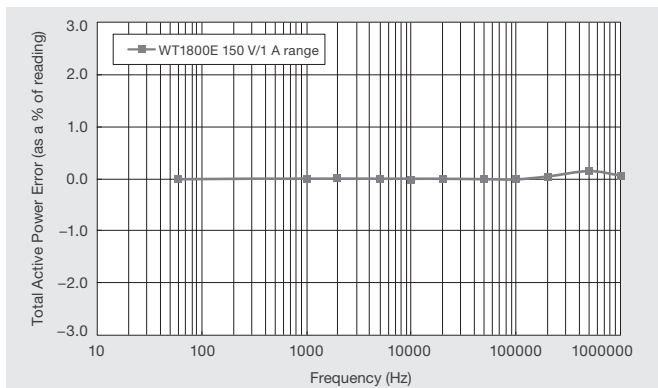

Example of frequency versus power accuracy characteristic at unity power factor

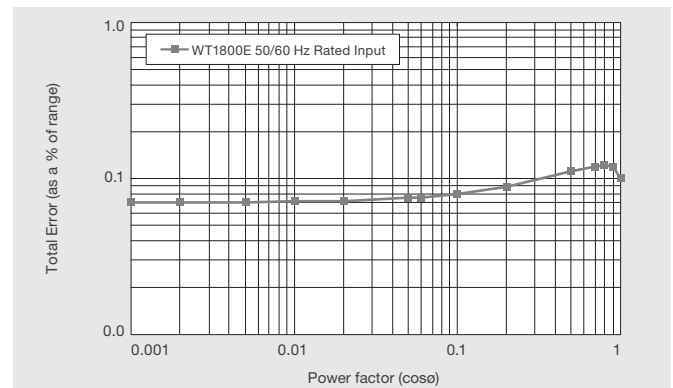

Total power error with rated range input for an arbitrary power factor (50/60 Hz)

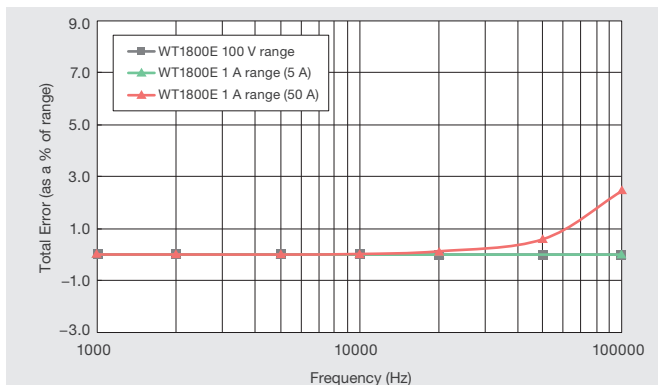

Example of effect of common mode voltage on readings

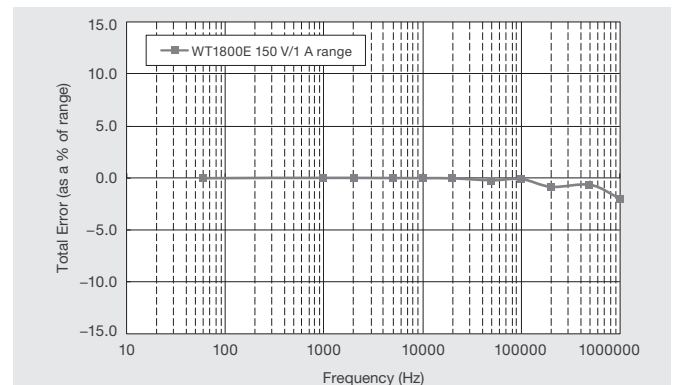

Example of frequency versus power accuracy at zero power factor

Applications

The WT1800E is a versatile instrument, unlocking precision power measurement capabilities for researchers, designers and engineers working on a wide variety of applications in energy efficiency and conservation and renewable energy. Whether it is for the manufacture of energy efficient devices and appliances, hybrid/electric vehicles or renewable energy technologies, the WT1800E is a universal meter for power electronic measurements and energy analysis. Key applications include:

- Plug-in Hybrid and Electric Vehicles
- Industrial equipment such as Inverters, Motors and Pumps
- Renewable energy technologies such as Solar and Wind power
- Office and Home appliances like Air conditioners and Refrigerators
- IT Data center equipment like Servers, Routers and Switches
- Battery charging and Portable devices
- Ballasts, LEDs & Fluorescent lighting
- Aircraft Power systems

The following pages cover some typical applications for the WT1800E.



Inverter and motor testing

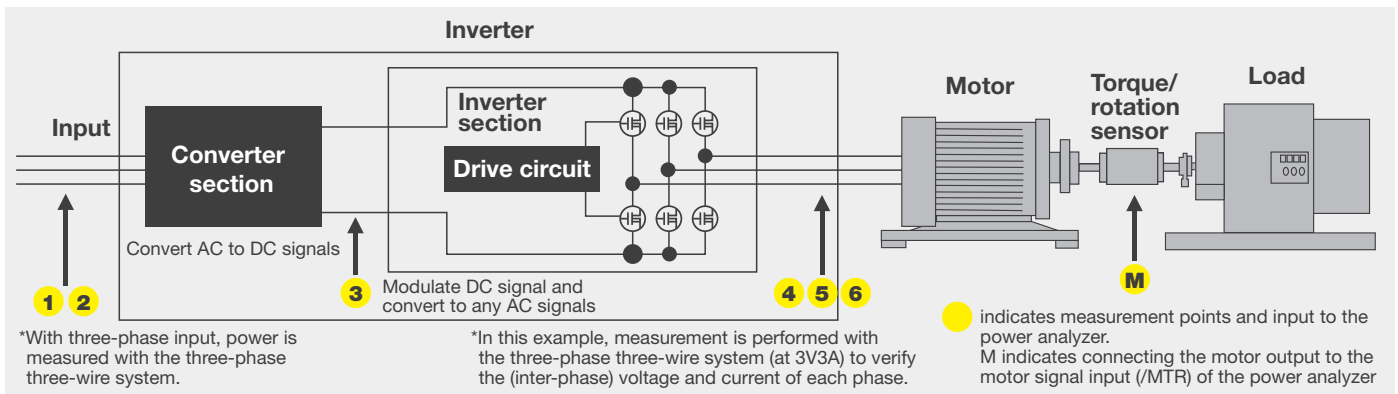

Overview

Electric and hybrid vehicles have many electrical and mechanical components and therefore an overall performance evaluation requires the efficiency measurement of both. With 6 channels of power inputs, flexible operation and a wide bandwidth, the WT1800E is ideal for efficiency tests between the input and output of inverters. An optional motor evaluation function enables the measurement of rotation speed and changes in torque.

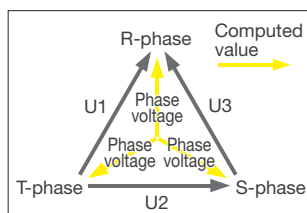
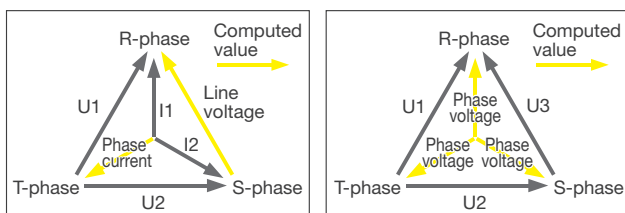

Figure 1 Line voltage/phase current

Figure 2 Delta-star conversion

Delta computation

Obtain the line and phase voltages from the sums and differences of the instantaneous values of voltage and current in each element.

- Line voltages and phase currents that are not measured are computed in the three-phase three-wire system (Figure 1).
- Star-delta conversion: Line voltage is computed from the phase voltage using the three-phase four-wire system data.
- Delta-star conversion: Phase voltage is computed from the line voltage in the three-phase three-wire system (3V3A system) (Figure 2).

The WT1800E advantages

Wide bandwidth and High speed sampling

The WT1800E is capable of 16-bit high resolution and 2 MHz sampling making it possible to measure faster signals with higher precision.

Motor evaluation: Electrical angle/rotation/direction

Measure rotation speed, torque, and output (mechanical power) of motors from analog/pulse inputs of rotation or torque sensors.

Harmonics and dual harmonics

Simultaneously measure distortion factors like THD, fundamental and harmonic components. Harmonics up to the 500th order can be measured even at 50 ms data update rate. Users can also measure harmonics on two different sources simultaneously.

Battery charge/discharge measurements

In integrated measurement, the battery charge and discharge can be evaluated. Instantaneous positive and negative values captured at a high-speed sampling rate of 2 MS/s are integrated.

Line filter to remove high frequency components

In the power evaluation of inverter waveforms, measurement values are affected by high frequency components. A digital filter function makes it possible to remove unnecessary high frequency components superimposed on signals. The filter can be independently set for each input element. An analog filter for 1 MHz/300 kHz, and a digital filter that can be set from 100 Hz to 100 kHz in increments of 100 Hz are available as standard.

Efficiency of renewable energy systems

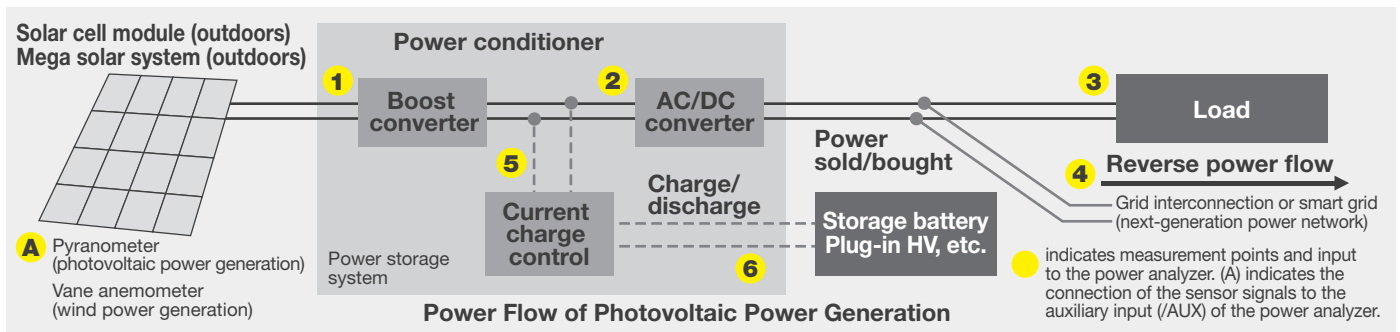

Overview

Energy generated by photovoltaic cell modules and wind turbines is converted from DC to AC by a power conditioner. Minimizing losses in these conversions improves the efficiency in the overall energy system. The WT1800E provides up to 6 power inputs per unit for measuring voltage, current, power, and frequency (for AC) before and after each converter, as well as the converter and charging efficiencies.

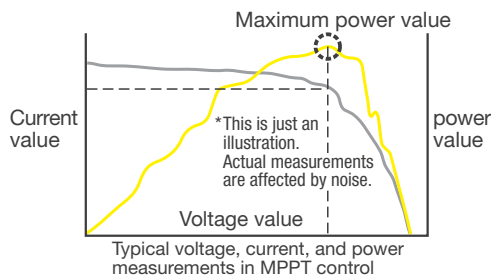

Measuring instantaneous peak power

In photovoltaic power generation, an MPPT control varies the voltage to maximize energy harvested from the solar panel. The WT1800E is capable of measuring not only the voltage, current, and power but also the voltage, current, and power peak values for both plus (+) and minus (-) sides.

The WT1800E advantages

Multiple channels and wide input range

Evaluate Power conditioner efficiency using 6 input channels for simultaneous measurements from the inputs and outputs of boost converter, inverter, and storage battery. Direct input terminals (voltage range: 1.5 V to 1000 V and current range: 10 mA to 5 A or 1 A to 50 A) make it possible to perform high-precision measurements without using a current sensor.

Harmonic distortion factor measurement

Voltage fluctuations and harmonics flow into the power system due to reverse power flow. A harmonic measurement function enables measurement of harmonic components to compute and display total harmonic distortion factor (THD).

Ripple factor and power loss measurements

A user-defined function makes it possible to compute power loss, DC voltage and DC current ripple factors between the input and output. Up to 20 arithmetic expressions can be set. Display names for the arithmetic operations F1, F2, and so on can be freely changed.

Typical arithmetic expressions

1. DC voltage ripple factor = $[(\text{Voltage peak value (+)} - \text{Voltage peak value (-)}) / 2 \times \text{DC voltage value (mean)}] \times 100$
2. Power loss = Output power - Input power

Energy bought/sold and charged/discharged

Measure the amount of power sold/bought in grid interconnection and of battery charge/discharge. Measure the amount of power sold/bought in grid interconnections and in battery charge/discharges. The WT1800E enables the integration of current (q), apparent power (WS), reactive power (WQ), as well as the effective power integration in sold/bought power and charge/discharge modes. Furthermore, a user-defined function makes it possible to calculate the Average active power within the integration period.

Efficiency of inverter-motor in electric vehicles

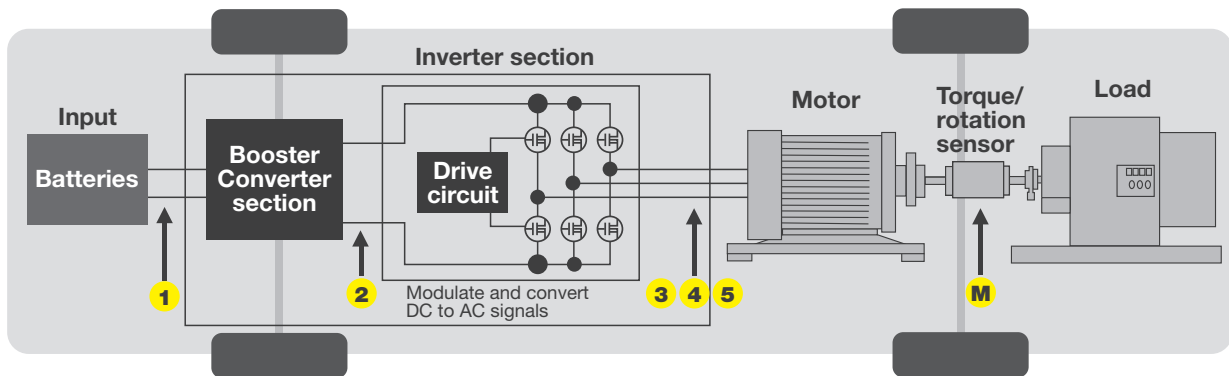

Overview

The WT1800E supports power measurements on up to 6 input channels making it ideal for evaluating the efficiency between the input and output of an electric vehicle. A motor evaluation function (option) makes it possible to simultaneously monitor voltage, current, and power changes, as well as changes in rotation speed, torque and mechanical power.

Typical repetitive high-speed charging and discharging signals

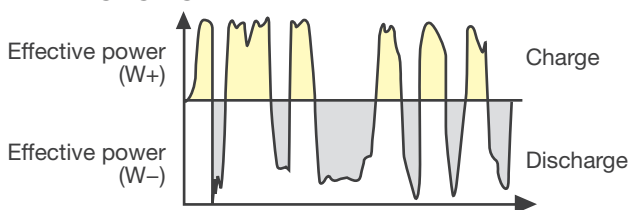

Charge current amount Ah (power amount Wh) and discharge current amount-Ah (power amount-Wh) can be integrated.

Battery charge/discharge measurements

In integrated measurement, the battery charge and discharge can be evaluated. Instantaneous positive and negative values captured at 2 MS/s high-speed sampling rate are integrated, and each of the total values is displayed.

The WT1800E advantage

Wide bandwidth and High speed sampling

The WT1800E is capable of 16-bit high resolution and 2 MHz sampling making it possible to measure faster signals with greater precision.

Harmonics and dual harmonics

Motor testing is performed at various rotation speeds. The WT1800E supports a lower limit frequency of 0.1 Hz to enable measurement of harmonics at a very low motor rotation speed without using an external sampling clock.

Motor evaluation:

Electrical angle/rotation/direction

Measure rotation speed, torque, and output (mechanical) power of motors from analog/pulse outputs of rotation or torque sensors.

Individual null function:

Offset correction for each input

A common problem when testing inverter motors is the presence of ambient noise that can mean test values are non zero even before testing begins. The WT1800E's null function allows users to enable, disable or reset the offset values for voltage, current and motor input signals of each element separately.

DA output and remote control

Sometimes users may want to check changes in data, along with other measurement data (temperature, etc.) at the same time that communication data, such as voltage, current, power, and efficiency is required. A DA output function allows users to generate analog signals on up to 20 channels.

Specifications

Inputs	
Input terminal type	
Voltage	Plug-in terminal (safety terminal)
Current	Direct input: Large binding post External current sensor input: Insulated BNC connector
Input type	
Voltage	Floating input, resistive potential method
Current	Floating input, shunt input method
Measurement range	
Voltage	1.5 V, 3 V, 6 V, 10 V, 15 V, 30 V, 60 V, 100 V, 150 V, 300 V, 600 V, 1000 V (for Crest factor CF3) 0.75 V, 1.5 V, 3 V, 5 V, 7.5 V, 15 V, 30 V, 50 V, 75 V, 150 V, 300 V, 500 V (for Crest factor CF6/CF6A)
Current	Direct input 50 A input element 1 A, 2 A, 5 A, 10 A, 20 A, 50 A (for Crest factor CF3) 500 mA, 1 A, 2.5 A, 5 A, 10 A, 25 A (for Crest factor CF6/CF6A) 5 A input element 10 mA, 20 mA, 50 mA, 100 mA, 200 mA, 500 mA, 1 A, 2 A, 5 A (for Crest factor CF3) 5 mA, 10 mA, 25 mA, 50 mA, 100 mA, 250 mA, 500 mA, 1 A, 2.5 A (for Crest factor CF6/CF6A) External current sensor input 50 mV, 100 mV, 200 mV, 500 mV, 1 V, 2 V, 5 V, 10 V (for Crest factor CF3) 25 mV, 50 mV, 100 mV, 250 mV, 500 mV, 1 V, 2.5 V, 5 V (for Crest factor CF6/CF6A)
Instrument loss	
Voltage	Input resistance: Approximately 2 MΩ Input capacitance: Approximately 10 pF
Current	Direct input 50 A input element Approximately 2 mΩ + approximately 0.07 μH 5 A input element Approximately 100 mΩ + approximately 0.07 μH External current sensor input Approximately 1 MΩ
Instantaneous maximum allowable input (20 ms or less)	
Voltage	Peak voltage of 4 kV or RMS of 1.5 kV, whichever is lower
Current	Direct input 50 A input element Peak current of 450 A or RMS of 300 A, whichever is lower 5 A input element Peak current of 30 A or RMS of 15 A, whichever is lower External current sensor input Peak current is less than 10 times the range
Instantaneous maximum allowable input (1 second or less)	
Voltage	Peak voltage of 3 kV or RMS of 1.5 kV, whichever is lower
Current	Direct input 50 A input element Peak current of 150 A or RMS of 55 A, whichever is lower 5 A input element Peak current of 10 A or RMS of 7 A, whichever is lower External current sensor input Peak current is less than 10 times the range
Continuous maximum allowable input	
Voltage	Peak voltage of 2 kV or RMS of 1.1 kV, whichever is lower If the frequency of the input voltage exceeds 100 kHz, (1200 – f) Vrms or less The letter f indicates the frequency of the input voltage and the unit is kHz.
Current	Direct input 50 A input element Peak current of 150 A or RMS of 55 A, whichever is lower 5 A input element Peak current of 10 A or RMS of 7 A, whichever is lower External current sensor input Peak current is less than 5 times the range
Continuous maximum common mode voltage (50/60 Hz)	
Voltage input terminals: 1000 Vrms	
Current input terminals	with /EX option 1000 Vrms (Maximum allowable voltage that can be measured) 600 Vrms (Rated voltage of EN61010-2-030 standard) without /EX option 1000 Vrms External current sensor input connector: 600 Vrms
Important Safety Note: Do not touch the inside of the BNC connector of the External Current Sensor input for safety reasons.	
Rated voltage to ground	
Voltage input terminals: 1000 V	
Current input terminals	with /EX option 1000 V (Maximum allowable voltage that can be measured) 600 V (Rated voltage of EN61010-2-030 standard) without /EX option 1000 V External current sensor input connector: 600 V
Important Safety Note: Do not touch the inside of the BNC connector of the External Current Sensor input for safety reasons.	
Influence from common voltage	
Apply 1000 Vrms for input terminal and case with the voltage input terminals shorted, the current input terminals open, and the external current sensor input terminals shorted.	
<ul style="list-style-type: none"> 50/60 Hz: ±0.01% of range or less Reference value up to 100 kHz: ±[(maximum rated range) / (rated range)] × 0.001 × f % of range or less. For external current sensor input, add ±[(maximum rated range / rated range) × [0.0125 × log (f × 1000) – 0.021]]% of range. However, 0.01% or more. <p>The unit of f is kHz. The maximum rated range within the equation is 1000 V or 50 A or 5 A or 10 V.</p>	
Line filter	Select OFF, 100 Hz to 100 kHz (in increments of 100 Hz), 300 kHz, or 1 MHz
Frequency filter	Under condition of other than Auto data update interval Select OFF, 100 Hz, or 1 kHz Under condition of Auto data update interval OFF, 100 Hz, 200 Hz, 400 Hz, 800 Hz, 1.6 kHz, 3.2 kHz, 6.4 kHz, 12.8 kHz and 25.6 kHz
A/D converter	Simultaneous voltage and current input conversion Resolution: 16-bit Conversion speed (sampling period): Approximately 500 ns. See harmonic measurement items for harmonic measurement.
Range switching	A range can be set for each input element

Auto range functions

Range up

- When the measured values of Urms and Irms exceed 110% of the range (exceed 220% when crest factor is set to CF6A)
- When the peak value of the input signal exceeds approximately 330% of the range (or approximately 660% for crest factor CF6/CF6A)

Range down: When the following conditions are met, the range setting switches down.

- When the measured values of Urms and Irms fall to 30% or less of the range
- When the measured values of Urms and Irms fall to 105% or less of the lower range (range to which the range setting switches down)
- When the measured values of Upeak and Ipeak fall to 300% or less of the lower range (600% or less for crest factor CF6/CF6A)

Display

Display 8.4-inch color TFT LCD display

Total number of pixels*

1024 (horizontal) × 768 (vertical) dots

*Up to approximately 0.002% of the pixels on the LCD may be defective.

Display update rate

Same as the data update rate.

- The display update interval of numeric display alone is 200 ms to 500 ms (which varies depending on the number of display items) when the data update rate is 50 ms, 100 ms, and 200 ms.
- The display update interval of display items other than numeric display (including custom displays) is approximately 1 s when the data update interval is 50 ms, 100 ms, 200 ms, and 500 ms.
- If the measurement mode display is set to Normal Mode (Trg), measurement takes place from when a trigger is detected over the data update interval.
The following amount of time is required for the WT1800E to compute the measured data, process it for displaying, and so on, and become ready for the next trigger.
 - When the data update interval is 50 ms to 500 ms: Approximately 1 s
 - When the data update interval is 1 s to 5 s: Data update interval + 500 ms

In this case, storage, communication output, and D/A output operate in sync with the triggers. If the measurement mode display is set to Normal Mode, storage, communication output, and D/A output operate in sync with the data update interval.
- The display update interval is more than 200 ms in the case of numerical value indication when update interval is set to Auto. In addition, the interval is more than 1 s in case of other display indications including Custom screen excepting the numerical value.

Display Items

Calculation Functions

Measurement Function	Single-phase 3-wire	3-phase 3-wire	3-phase 3-wire (3-voltage 3-current measurement)	3-phase 4-wire
Voltage U_{Σ} [V]	$(U1+U2)/2$		$(U1+U2+U3)/3$	
Current I_{Σ} [A]	$(I1+I2)/2$		$(I1+I2+I3)/3$	
Active power P_{Σ} [W]	P1+P2			P1+P2+P3
Apparent Power S_{Σ} [VA]	TYPE1	S1+S2	$\frac{\sqrt{3}}{2} (S1+S2)$	$\frac{\sqrt{3}}{3} (S1+S2+S3)$
	TYPE2	$\sqrt{P_{\Sigma}^2 + Q_{\Sigma}^2}$		
	TYPE3	$\sqrt{S_{\Sigma}^2 - P_{\Sigma}^2}$		
Reactive Power Q_{Σ} [var]	TYPE1	Q1+Q2		Q1+Q2+Q3
	TYPE2	$\sqrt{S_{\Sigma}^2 - P_{\Sigma}^2}$		
	TYPE3	Q1+Q2		Q1+Q2+Q3
Corrected Power Pc_{Σ} [W]	Pc1+Pc2			Pc1+Pc2+Pc3
Integrated Power WP_{Σ} [Wh]	WP1+WP2			WP1+WP2+WP3
Integrated Power (Positive) $WP_{+\Sigma}$ [Wh]	When WPTYPE is set to CHARGE/DISCHARGE			
	When WPTYPE is set to SOLD/BOUGHT Whenever data is updated, only the positive value of active power WP_{Σ} is added This item is not calculated when Data update interval is set to Auto			
	WP ₋₁ +WP ₋₂			
Integrated Power (Negative) $WP_{-\Sigma}$ [Wh]	When WPTYPE is set to CHARGE/DISCHARGE			
	When WPTYPE is set to SOLD/BOUGHT Whenever data is updated, only the negative value of active power WP_{Σ} is added This item is not calculated when Data update interval is set to Auto			
	WP ₋₁ +WP ₋₂ +WP ₋₃			
Integrated Current q_{Σ} [Ah]	q1+q2		q1+q2+q3	
Integrated Current (Positive) $q_{+\Sigma}$ [Ah]	q ₋₁ +q ₋₂			q ₋₁ +q ₋₂ +q ₋₃
Integrated Current (Negative) $q_{-\Sigma}$ [Ah]	q ₋₁ +q ₋₂			q ₋₁ +q ₋₂ +q ₋₃
Integrated reactive Power WQ_{Σ} [varh]	$\frac{1}{N} \sum_{n=1}^N Q_{\Sigma}(n) \times \text{Time}$ Q $_{\Sigma}(n)$ indicates the Σ function of the n th reactive power, N indicates the number of data updates, and the unit of Time is h This item is not calculated when Data update interval is set to Auto			
Integrated apparent Power WS_{Σ} [VAh]	$\frac{1}{N} \sum_{n=1}^N S_{\Sigma}(n) \times \text{Time}$ S $_{\Sigma}(n)$ indicates the Σ function of the n th apparent power, N indicates the number of data updates, and the unit of Time is h This item is not calculated when Data update interval is set to Auto			
Power Factor Σ	P_{Σ}/S_{Σ}			
Phase angle Q_{Σ} [°]	$\text{COS}^{-1} (P_{\Sigma}/S_{\Sigma})$			

Note 1) The instrument's apparent power (S), reactive power (Q), power factor (λ), and phase difference (θ) are calculated using measured values of voltage, current, and active power.
(However, reactive power is calculated directly from sampled data when TYPE3 is selected.) Therefore, when distorted waveforms are input, these values may be different from those of other measuring instruments based on different measuring principals.

Note 2) The value of Q for each phase in the QΣ calculation is calculated with a preceding minus sign (-) when the current input leads the voltage input, and a plus sign when it lags the voltage input, so the value of QΣ may be negative.

Numerical Display

[Measurement functions obtained for each input element]

Voltage (V)	Urms: True RMS value, Umn: Rectified mean value calibrated to the RMS value, Udc: Simple mean value, Umn: Rectified mean value, Uac: AC component
Current (A)	Urms: True RMS value, Imn: Rectified mean value calibrated to the RMS value, Idc: Simple mean value, Imn: Rectified mean value, Iac: AC component
Active power (W)	P
Apparent power (VA)	S
Reactive power (var)	Q
Power factor	λ
Phase angle (°)	∅
Frequency (Hz)	fU (FreqU): Voltage frequency, fI (FreqI): Current frequency
Maximum and minimum voltage values (V)	U+peak: Maximum voltage value, U-peak: Minimum voltage value
Maximum and minimum current values (A)	I+peak: Maximum current value, I-peak: Minimum current value
Maximum and minimum power values (W)	P+peak: Maximum power value, P-peak: Minimum power value
Crest factor	CfU: Voltage crest factor, CfI: Current crest factor
Corrected power (W)	Pc Applicable standards IEC76-1 (1976), IEC76-1 (1993)
Integration	Time: Integration time WP: Sum of the amount of both positive and negative power WP+: Sum of positive P (amount of power consumed) WP-: Sum of negative P (amount of power returned to the grid) q: Sum of the amount of both positive and negative current q+: Sum of positive I (amount of current) q-: Sum of negative I (amount of current) WS*: Amount of apparent power WQ*: Amount of reactive power However, the amount of current is integrated by selecting any one of Irms, Imn, Idc, Iac, and Imn depending on the setting of the current mode. *Excepting when data update interval is set to Auto.

[Measurement function (Σ function) obtained for each connected unit (ΣA, ΣB, ΣC)]

Voltage (V)	UrmsΣ: True RMS value, UmnΣ: Rectified mean value calibrated to the RMS value, UdcΣ: Simple mean value, UmnΣ: Rectified mean value, UacΣ: AC component
Current (A)	IrmsΣ: True RMS value, ImnΣ: Rectified mean value calibrated to the RMS value, IdcΣ: Simple mean value, ImnΣ: Rectified mean value, IacΣ: AC component
Active power (W)	PΣ
Apparent power (VA)	SΣ
Reactive power (var)	QΣ
Power factor	λΣ
Corrected power (W)	PcΣ Applicable standards IEC76-1 (1976), IEC76-1 (1993)
Integration	TimeΣ: Integration time WPΣ: Sum of the amount of both positive and negative power WP+Σ: Sum of positive P (amount of power consumed) WP-Σ: Sum of negative P (amount of power returned to the grid) qΣ: Sum of the amount of both positive and negative current q+Σ: Sum of positive I (amount of current) q-Σ: Sum of negative I (amount of current) WSΣ: Integration of SΣ WQΣ: Integration of QΣ

Harmonic Measurement (Option)

[Measurement function obtained for each input element]

Voltage (V)	U (k): RMS value of the harmonic voltage of order k ¹ , U: Voltage RMS value (Total value ²)
Current (A)	I (k): RMS value of the harmonic current of order k, I: Current RMS value (Total value ²)
Active power (W)	P (k): Active power of the harmonic of order k, P: Active power (Total value ²)
Apparent power (VA)	S (k): Apparent power of the harmonic of order k, S: Total apparent power (Total value ²)
Reactive power (var)	Q (k): Reactive power of the harmonic of order k, Q: Total reactive power (Total value ²)
Power factor	λ (k): Power factor of the harmonic of order k, λ: Total power factor (Total value ²)
Phase angle (°)	∅ (k): Phase angle between the harmonic voltage and current of order k, ∅: Total phase angle ∅ U (k): Phase angle of each harmonic voltage U (k) relative to the fundamental wave U (1) ∅ I (k): Phase angle of each harmonic current I (k) relative to the fundamental wave I (1)
Impedance of the load circuit (Ω)	Z (k): Impedance of the load circuit for the harmonic of order k

Resistance and reactance of the load circuit (Ω)

Rs (k): Resistance of the load circuit to the harmonic of order k when the resistance R, the inductance L, and the capacitor C are connected in series
Xs (k): Reactance of the load circuit to the harmonic of order k when the resistance R, the inductance L, and the capacitor C are connected in series
Rp (k): Resistance of the load circuit to the harmonic of order k when the resistance R, the inductance L, and the capacitor C are connected in parallel
Xp (k): Reactance of the load circuit to the harmonic of order k when the resistance R, the inductance L, and the capacitor C are connected in parallel

Harmonic content [%]	Uhdf (k): Ratio of the harmonic voltage U (k) to U (1) or U lhdf (k): Ratio of the harmonic current I (k) to I (1) or I Phdf (k): Ratio of the active harmonic power P (k) to P (1) or P
----------------------	--

Total harmonic distortion [%]	Uthd: Ratio of the total harmonic ³ voltage to U (1) or U Ithd: Ratio of the total harmonic ³ current to I (1) or I Pthd: Ratio of the total harmonic ³ active power to P (1) or P
-------------------------------	---

Telephone harmonic factor	Uthf: Voltage telephone harmonic factor, Ithf: Current telephone harmonic factor Applicable standard: IEC34-1 (1996)
---------------------------	--

Telephone influence factor	Utif: Voltage telephone influence factor, Itif: Current telephone influence factor Applicable standard: IEEE Std 100 (1996)
----------------------------	---

Harmonic voltage factor ⁴	hvf: harmonic voltage factor
--------------------------------------	------------------------------

Harmonic current factor ⁴	hcf: harmonic current factor
--------------------------------------	------------------------------

K-factor	Ratio of the sum of the squares of weighted harmonic components to the sum of the squares of the orders of harmonic current
----------	---

- *1: Order k is an integer in the range from 0 to the upper limit value for the measured order. The 0th order is a DC current component (dc). The upper limit value for the measured order is automatically determined up to the 500th order depending on the frequency of the PLL source.
- *2: The total value is calculated by obtaining the fundamental wave (the 1st order) and all harmonic components (from the 2nd order to the upper limit value for the measured order). Also, the DC component (dc) can be added to the equation.
- *3: The total harmonic is calculated by obtaining the total harmonic component (from the 2nd order to the upper limit value for the measured order)
- *4: The equations may vary depending on the definitions in the standards, etc. Check the standards for details.

[Measurement function indicating the phase difference of the fundamental wave between the voltage and current between input elements]

This is a measurement function indicating the phase angle of the fundamental wave U (1) or I (1) of another element to the fundamental wave U (1) of the element with the smallest number among input elements assigned to the connected unit. The following table shows measurement functions for the connected unit with a combination of the elements 1, 2, and 3.

Phase angle U1-U2 (°)	∅U1-U2: Phase angle of the fundamental wave (U2 (1)) of the voltage of the element 2 to the fundamental wave (U1 (1)) of the voltage of the element 1
Phase angle U1-U3 (°)	∅U1-U3: Phase angle of the fundamental wave (U3 (1)) of the voltage of the element 3 to U1 (1)
Phase angle U1-I1 (°)	∅U1-I1: Phase angle of the fundamental wave (I1 (1)) of the current of the element 1 to U1 (1)
Phase angle U2-I2 (°)	∅U2-I2: Phase angle of the fundamental wave (I2 (1)) of the current of the element 2 to U2 (1)
Phase angle U3-I3 (°)	∅U3-I3: Phase angle of the fundamental wave (I3 (1)) of the current of the element 3 to U3 (1)
EaU1 to EaU6 (°), EaI1 to EaI6 (°)	Phase angle ∅ of the fundamental waves of U1 to I6 based on the rise of the Z terminal input in the motor evaluation function (option). N is the set value for the number of poles in the motor evaluation function.

[Measurement function (Σ function) obtained for each connected unit (ΣA, ΣB, ΣC)]

Voltage (V)	UΣ (1): RMS of the harmonic voltage of order 1, UΣ: RMS of the voltage (Total value*)
Current (A)	IΣ (1): RMS of the harmonic current of order 1, IΣ: RMS of the current (Total value*)
Active power (W)	PΣ (1): Harmonic active power of order 1, PΣ: Total active power (Total value*)
Apparent power (VA)	SΣ (1): Harmonic apparent power of order 1, SΣ: Total apparent power (Total value*)
Reactive power (var)	QΣ (1): Harmonic reactive power of order 1, QΣ: Total reactive power (Total value*)
Power factor	λΣ (1): Harmonic power factor of order 1, λΣ: Total power factor (Total value*)

*The total value is calculated by obtaining the fundamental wave (the 1st order) and all harmonic components (from the 2nd order to the upper limit value for the measured order). Also, the DC component (dc) can be added to the equation.

Delta Calculation

Voltage (V)	difference	ΔU1: Differential voltage between U1 and U2 determined by computation
3P3W->3V3A	ΔU1: Line voltage that is not measured but can be computed for a three-phase, three-wire system	
DELTA->STAR	ΔU1, ΔU2, ΔU3: Phase voltage that can be computed by a three-phase, three-wire (3V3A) system ΔUΣ = (ΔU1 + ΔU2 + ΔU3)/3	
STAR->DELTA	ΔU1, ΔU2, ΔU3: Line voltage that can be computed for a three-phase, four-wire system ΔUΣ = (ΔU1 + ΔU2 + ΔU3)/3	

Current (A)	difference	$\Delta I1$: Differential current between I1 and I2 determined by computation
	3P3W->3V3A	ΔI : Phase current that is not measured
	DELTA->STAR	ΔI : Neutral line current
	STAR->DELTA	ΔI : Neutral line current
Power (W)	difference	—
	3P3W->3V3A	—
	DELTA->STAR	$\Delta P1, \Delta P2, \Delta P3$: Phase power determined by computation for a three-phase, three-line (3V3A) system $\Delta P\Sigma = \Delta P1 + \Delta P2 + \Delta P3$
	STAR->DELTA	—

Waveform/Trend	
Waveform display	Displays the waveforms of the voltage and current from elements 1 through 6, torque, speed, AUX1, and AUX2.
Trend display	Displays trends in numerical data of the measurement functions in a sequential line graph. Number of measurement channels: Up to 16 parameters

Bar Graph/Vector (G5, /G6 Option)	
Bar graph display	Displays the size of each harmonic in a bar graph.
Vector display	Displays the vector of the phase difference in the fundamental waves of voltage and current.

Accuracy

Voltage and Current: Accuracy (six-month)
 Conditions Temperature: 23±5°C, Humidity: 30 to 75%RH, Input waveform: Sine wave, Power factor (λ): 1, Common mode voltage: 0 V, Crest factor: CF3, Line filter: OFF
 Frequency filter: 1 kHz or less when ON, after warm-up.
 After zero level compensation or range value changed while wired. The unit of f within the accuracy equation is kHz.

Voltage	Frequency	Accuracy ±(Measurement reading error + Setting range error)
	DC	±(0.05% of reading + 0.05% of range)
	0.1 Hz ≤ f < 10 Hz	±(0.03% of reading + 0.05% of range)
	10 Hz ≤ f < 45 Hz	±(0.03% of reading + 0.05% of range)
	45 Hz ≤ f ≤ 66 Hz	±(0.03% of reading + 0.05% of range)*
	66 Hz < f ≤ 1 kHz	±(0.1% of reading + 0.1% of range)
	1 kHz < f ≤ 50 kHz	±(0.3% of reading + 0.1% of range)
	50 kHz < f ≤ 100 kHz	±(0.6% of reading + 0.2% of range)
	100 kHz < f ≤ 500 kHz	±[(0.006 × f)% of reading + 0.5% of range]
	500 kHz < f ≤ 1 MHz	±[(0.022 × f - 8)% of reading + 1% of range]
Frequency bandwidth	5 MHz (-3 dB, typical)	

*Add 0.02% of reading under condition of the 1000 V range.

Current	Frequency	Accuracy ±(Measurement reading error + Setting range error)
	DC	±(0.05% of reading + 0.05% of range)
	0.1 Hz ≤ f < 10 Hz	±(0.03% of reading + 0.05% of range)
	10 Hz ≤ f < 45 Hz	±[(0.03% of reading + 0.05% of range) + (2 μA*)]
	45 Hz ≤ f ≤ 66Hz	±[(0.03% of reading + 0.05% of range) + (2 μA*)]
	66 Hz < f ≤ 1 kHz	±(0.1% of reading + 0.1% of range) Direct input of the 50 A input element ±(0.2% of reading + 0.1% of range)
	1 kHz < f ≤ 50 kHz	±(0.3% of reading + 0.1% of range) 50 mV, 100 mV, 200 mV range of the external current sensor input ±(0.5% of reading + 0.1% of range) Direct input of the 50 A input element ±[(0.1 × f + 0.2)% of reading + 0.1% of range]
	50 kHz < f ≤ 100 kHz	±(0.6% of reading + 0.2% of range) Direct input of the 50 A input element ±[(0.1 × f + 0.2)% of reading + 0.1% of range]
	100 kHz < f ≤ 200 kHz	±[(0.006 × f)% of reading + 0.5% of range] Direct input of the 50 A input element ±[(0.05 × f + 5)% of reading + 0.5% of range]
	200 kHz < f ≤ 500 kHz	±[(0.006 × f)% of reading + 0.5% of range] Direct input of the 50 A input element: It does not define accuracy.
	500 kHz < f ≤ 1 MHz	±[(0.022 × f - 8)% of reading + 1% of range] Direct input of the 50 A input element: It does not define accuracy.
	Frequency bandwidth	5 MHz (-3 dB, typical); 5 A input element, External current sensor input of the 50 A input element

*Not added under the External current sensor input setting

Power: Accuracy (six-month)

Conditions Same as the accuracy of the voltage and current

Frequency	Accuracy ±(Reading error + Measurement range error)
DC	±(0.05% of reading + 0.05% of range)
0.1 Hz ≤ f < 10 Hz	±(0.08% of reading + 0.1% of range)
10 Hz ≤ f < 45 Hz	±[(0.08% of reading + 0.1% of range) + (2 μA × U)*]
45 Hz ≤ f ≤ 66 Hz	±[(0.05% of reading + 0.05% of range) + (2 μA × U)*]
66 Hz < f ≤ 1 kHz	±(0.2% of reading + 0.1% of range)
1 kHz < f ≤ 50 kHz	±(0.3% of reading + 0.2% of range) 50 mV, 100 mV, 200 mV range of the external current sensor input ±(0.5% of reading + 0.2% of range) Direct input of the 50 A input element ±[(0.1 × f + 0.2)% of reading + 0.2% of range]
50 kHz < f ≤ 100 kHz	±(0.7% of reading + 0.3% of range) Direct input of the 50 A input element ±[(0.3 × f - 9.5)% of reading + 0.3% of range]
100 kHz < f ≤ 200 kHz	±[(0.008 × f)% of reading + 1% of range] Direct input of the 50 A input element ±[(0.09 × f + 11)% of reading + 1% of range]
200 kHz < f ≤ 500 kHz	±[(0.008 × f)% of reading + 1% of range] Direct input of the 50 A input element: It does not define accuracy.
500 kHz < f ≤ 1 MHz	±[(0.048 × f - 20)% of reading + 2% of range] Direct input of the 50 A input element: It does not define accuracy.

*Not added under the External current sensor input setting

- Add the following value to the above accuracy for the external current sensor range.
Current DC accuracy: ±50 μV
Power DC accuracy: ±[(50 μV/External current sensor range rating) × 100% of range]
- Add the following value to the above accuracy for the direct current input range.
50 A input element
Current DC accuracy: ±1.5 mA
Power DC accuracy: ±[(1 mA/Direct current input range rating) × 100% of range]
5 A input element
Current DC accuracy: ±15 μA
Power DC accuracy: ±[(10 μA/Direct current input range rating) × 100% of range]
- Accuracy of the waveform display data, U_{peak} and I_{peak}
Add the following value to the above accuracy (reference value). The effective input range is within ±300% of range (within ±600% for Crest factor CF6/CF6A)

Voltage input: $\pm \left[1.5 \times \sqrt{\frac{15}{\text{range}}} + 0.5 \right] \% \text{ of range}$

Direct current input 50 A input element: $\pm \left[3 \times \sqrt{\frac{1}{\text{range}}} \% \text{ of range} + 10 \text{ mA} \right]$

5 A input element: $\pm \left[10 \times \sqrt{\frac{10 \text{ m}}{\text{range}}} + 0.5 \right] \% \text{ of range}$

External current sensor input 50 mV to 200 mV range: $\pm \left[10 \times \sqrt{\frac{0.01}{\text{range}}} + 0.5 \right] \% \text{ of range}$

500 mV to 10 V range: $\pm \left[10 \times \sqrt{\frac{0.05}{\text{range}}} + 0.5 \right] \% \text{ of range}$

- Influence from a temperature change after zero level compensation or range change
Add the following value to the above accuracy.
Voltage DC accuracy: ±0.02% of range/°C
DC accuracy of the direct current input
50 A input element: ±1 mA/°C
5 A input element: ±10 μA/°C
DC accuracy of the external current sensor input: ±50 μV/°C
DC power accuracy: Influence from the voltage × influence from the current
- Influence from the self-heating caused by voltage input
Add the following value to the voltage and power accuracy.
AC input signal: ±(0.0000001 × U²% of reading)
DC input signal: ±(0.0000001 × U²% of reading + 0.0000001 × U²% of range)
U is the voltage reading (V).
The influence from the self-heating continues until the temperature of the input resistor decreases, even if the voltage input changes to a small value.
- Influence from the self-heating caused by current input
Add the following value to the current and power accuracy of the 50 A element.
AC input signal: ±(0.00006 × I²% of reading)
DC input signal: ±(0.00006 × I²% of reading + 0.004 × I² mA)
Add the following value to the current and power accuracy of the 5 A element.
AC input signal: ±0.006 × I²% of reading
DC input signal: ±(0.006 × I²% of reading + 0.004 × I² mA)
I is the current reading (A).
The influence from the self-heating continues until the temperature of the shunt resistor decreases, even if the current input changes to a small value.
- Range of guaranteed accuracy by frequency, voltage, and current
All accuracies between 0.1 Hz to 10 Hz are reference values.
If the voltage exceeds 750 V at 30 kHz to 100 kHz, the voltage and power values are reference values.
If the current exceeds 20 A at DC, 10 Hz to 45 Hz, or 400 Hz to 100 kHz, the current and power accuracies are reference values.
- Accuracy for Crest factor CF6/CF6A
Same as the range accuracy of Crest factor CF3 for twice the range.

Influence of power factor (λ)

When λ = 0 ±(Apparent power reading × 0.07% for the range) of 45 Hz to 66 Hz
 For frequencies other than the above (Design values):
 5 A input element and the external sensor input:
 ±[Apparent power reading × (0.07 + 0.05 × f)%]
 Direct input of the 50 A input element:
 ±[Apparent power reading × (0.07 + 0.3 × f)%]

When 0 < λ < 1 ±Power reading × [(Power reading error %) + (Power range error %) × (Power range/Apparent power reading) + [tan ∅ × (Influence % when λ = 0)]]
 ∅ is the phase angle between the voltage and current.
 "Influence % when λ = 0" will be changed according to input frequency f of above expression.

Influence of line filter
 When the cutoff frequency (fc) is 100 Hz to 100 kHz
 Voltage/current

$$\text{Up to } \frac{fc}{2} \text{ Hz: Add } \pm \left\{ 2 \times \left[1 - \sqrt{\frac{1}{1 + \left(\frac{f}{fc}\right)^4}} \right] \times 100 + \left(20 \times \frac{f}{300 \text{ K}} \right) \% \text{ of reading} \right\}$$

Applies to frequency less than or equal to 30 kHz

Power

$$\text{Up to } \frac{fc}{2} \text{ Hz: Add } \pm \left\{ 4 \times \left[1 - \sqrt{\frac{1}{1 + \left(\frac{f}{fc}\right)^4}} \right] \times 100 + \left(40 \times \frac{f}{300 \text{ K}} \right) \% \text{ of reading} \right\}$$

Applies to frequency less than or equal to 30 kHz

When the cutoff frequency (fc) is 300 kHz and 1 MHz
 Voltage/current Up to (fc/10) Hz: Add $\pm(20 \times f/fc)\%$ of reading

Power Up to (fc/10) Hz: Add $\pm(40 \times f/fc)\%$ of reading

Lead/lag phase detection [D (LEAD)/G (LAG) of the phase angle]
 The phase lead and lag can be detected correctly when the voltage and current input signals are as follows.

- Sine wave
- 50% or more of the measurement range (100% or more for crest factor CF6/CF6A)
- Frequency: 20 Hz to 10 kHz
- Phase angle: $\pm(5^\circ \text{ to } 175^\circ)$

Symbols for the reactive power Q_r calculation
 The symbols shows the lead/lag of each element, and “-” indicates leading.

Temperature coefficient
 $\pm 0.03\%$ of reading/ $^\circ\text{C}$ at 5 to 18 $^\circ\text{C}$ or 28 to 40 $^\circ\text{C}$

Effective input range
 Udc and ldc: 0 to $\pm 110\%$ of the measurement range
 Urms and lrms: 1 to 110% of the measurement range
 Umn and lmn: 10 to 110% of the measurement range
 Urn and lrn: 10 to 110% of the measurement range
 Power (DC measurement): 0 to $\pm 110\%$
 (AC measurement): $\pm 110\%$ of the power range when the voltage and current range is 1 to 110%.

However, the synchronization source level shall meet the input signal level of frequency measurement. Each of the lower and higher limits are doubled for Crest factor CF6/CF6A.

Maximum display value
 140% of the voltage and current range rating
 When Crest factor is set to CF6A, 280% of the voltage and current range rating

Minimum display value
 Displays the following values relative to the measurement range.

- Urms, Uac, lrms, lac: Up to 0.3% (up to 0.6% for Crest factor CF6/CF6A)
- Urn, Urmn, lrn, lrnm: Up to 2% (up to 4% for Crest factor CF6/CF6A)

When input level is lower than above, the display shows zero if zero-suppress setting is ON, otherwise measured value will be shown. Current integration value q depends on the current value as well.

Measurement lower limit frequency

Data update rate	50 ms	100 ms	200 ms	500 ms
Measurement lower limit frequency	45 Hz	25 Hz	12.5 Hz	5 Hz

Data update rate	1 s	2 s	5 s	10 s	20 s	Auto
Measurement lower limit frequency	2.5 Hz	1.25 Hz	0.5 Hz	0.2 Hz	0.1 Hz	0.1 Hz

Accuracy of apparent power S
 $\pm(\text{Voltage accuracy} + \text{Current accuracy})$

Accuracy of reactive power Q
 $\pm[\text{Accuracy of apparent power} + (\sqrt{1.0004 - \lambda^2} - \sqrt{1 - \lambda^2}) \times 100\% \text{ of range}]$

Accuracy of power factor λ
 $\pm[(\lambda - \lambda / 1.0002) + |\cos \varnothing - \cos [\varnothing + \sin^{-1}(\text{influence of power factor of power when } \lambda = 0\% / 100)]|] \pm 1 \text{ digit}$ when voltage and current is at rated input of the measurement range. \varnothing is the phase difference of voltage and current.

Accuracy of phase angle \varnothing
 $\pm[|\varnothing - [\cos^{-1}(\lambda / 1.0002)] + \sin^{-1}(\text{influence of power factor of power when } \lambda = 0\% / 100)]|] \pm 1 \text{ digit}$, when voltage and current is at the rated input of the measurement range.

One-year accuracy
 Multiply the reading error of the six-month accuracy by a factor of 1.5

Functions

Measurement Functions and Conditions

Crest factor: 300 (relative to the minimum valid input)
 CF3: 3 (relative to the rated value of the measurement range)
 CF6/CF6A: 6 (relative to the rated value of the measurement range)

Measurement period
 Interval for determining the measurement function and performing calculations.

- The measurement period is set by the zero crossing of the reference signal (synchronization source) excluding watt hour WP and ampere hour q during DC mode. Timing of Data update is different (minimum time resolution is 50 ms) among elements with different reference signals (synch sources) setting when the Data update interval is set to Auto. Timeout period can be selected from 1 s, 5 s, 10 s or 20 s. And full period of timeout becomes actual measurement period when synchronization source signal does not input any cycles during the timeout period.
- Harmonic display
 The measurement period is from the beginning of the data update interval to 1024 or 8192 points at the harmonic sampling frequency.
- Measurement period detection method
 Analog signal zero cross detection method when Data update interval is set to other than Auto. In case of sampling data level detection method when Data update interval is set to Auto, data level can be set arbitrarily.

Wiring 1P2W (single-phase, two-wire), 1P3W (single-phase, 3-wire), 3P3W (3-phase, 3-wire), 3P4W (3-phase, 4-wire), 3P3W (3V3A) (3-phase, 3-wire, 3-volt/3-amp measurement)
 However, the number of available wiring systems varies depending on the number of installed input elements.

Scaling When inputting output from external current sensors, VT, or CT, set the current sensor conversion ratio, VT ratio, CT ratio, and power coefficient in the range from 0.0001 to 99999.9999.
 CT ratio can be set automatically by selecting a model name of CT series. Current sensor conversion ratio can be set automatically by selecting a model name of dedicated shunt resistors.

Averaging

- The average calculations below are performed on the normal measurement parameters of voltage U, current I, power P, apparent power S, and reactive power Q. Power factor λ and phase angle are determined by calculating the average of P and S.
- Select exponential or moving averaging.
 Exponential average: Select an attenuation constant from 2 through 64.
 Moving average: Select the number of averages from 8 through 64.
- Harmonic measurement
 Only exponential averaging is available.

Data update interval
 Select 50 ms, 100 ms, 200 ms, 500 ms, 1 s, 2 s, 5 s, 10 s, 20 s, or Auto.
 Period detection method is different depending on update interval.
 50 ms, 100 ms, 200 ms, 500 ms, 1 s, 2 s, 5 s, 10 s, 20 s : Analog signal zero cross detection method
 Auto: Sampling data level detection method

Response time
 At maximum, twice the data update interval (only during numerical display)
 When Data update interval is set to Auto, response time is signal cycle period and added 50 ms.

Hold Holds the data display.

Single Executes a single measurement during measurement hold.
 When the Data update interval is set to Auto, single measurement cannot be executed.

Zero level compensation/Null
 Compensates the zero level. Null compensation range: $\pm 10\%$ of range
 Null can be set individually for each of the following input signals.

- Voltage and current of each input element
- Rotation speed and torque
- AUX1 and AUX2

Frequency Measurement

Number of measurement The frequencies of voltages and currents for all input elements can be measured.

Measurement method Reciprocal method

Measurement range	Data update rate	Measuring range
	50 ms	45 Hz $\leq f \leq$ 1 MHz
100 ms	25 Hz $\leq f \leq$ 1 MHz	
200 ms	12.5 Hz $\leq f \leq$ 500 kHz	
500 ms	5 Hz $\leq f \leq$ 200 kHz	
1 s	2.5 Hz $\leq f \leq$ 100 kHz	
2 s	1.25 Hz $\leq f \leq$ 50 kHz	
5 s	0.5 Hz $\leq f \leq$ 20 kHz	
10 s	0.25 Hz $\leq f \leq$ 10 kHz	
20 s	0.15 Hz $\leq f \leq$ 5 kHz	
Auto	0.1 Hz $< f \leq$ 500 kHz	

Accuracy
 $\pm 0.06\%$ of reading ± 0.1 mHz
 When the input signal level is 30% or more of the measurement range (60% or more for Crest factor CF6/CF6A).
 However:

- The input signal is 50% or more of the range.
 The frequency is smaller or equal to 2 times of above lower frequency
 10 mA range setting of 5 A input element
 1 A range setting of 50 A input element
- When the Data update interval is set to other than Auto, the 100 Hz frequency filter is ON at 0.15 Hz to 100 Hz, and the 1 kHz frequency filter is ON at 100 Hz to 1 kHz.
- When the Data update interval is set to Auto, 100 Hz cutoff frequency filter is set to ON for 0.1 Hz to 100 Hz, and 1.6 kHz cutoff frequency filter is set to ON for 100 Hz to 1 kHz.

Display resolution 99999

Minimum frequency resolution 0.0001 Hz

Frequency measurement filter (the Data update interval is set to other than Auto)
 Select from OFF, 100 Hz or 1 kHz
 (the Data update interval is set to Auto)
 Select from OFF, 100 Hz, 200 Hz, 400 Hz, 800 Hz, 1.6 kHz, 3.2 kHz, 6.4 kHz, 12.8 kHz or 25.6 kHz.

Integration

Mode Select a mode from Manual, Standard, Continuous (repeat), Real Time Control Standard, and Real Time Control Continuous (Repeat).
 *When Data update interval is set to Auto, integration will executes in Manual mode and timer mode only. Other integration modes like Continuous, Real Time Control Standard and Real Time Control Continuous are not supported.

Integration timer
 Integration can be stopped automatically using the timer setting. 0000h00m00s to 1000h00m00s

Count over If the integration time reaches the maximum integration time (10000 hours), or if the integration value reaches maximum/minimum display integration value¹, the elapsed time and integration value is saved and the operation is stopped.

*1: WP: ±999999 MWh
 q: ±999999 MAh
 WS: ±999999 MVAh
 WQ: ±999999 Mvarh

- Integration Resume Action after Recovery of Power Failure
 Even if a case of power supply loss due to instantaneous power failure while integration, integration can be continued after the recovery.
 When Data update interval is set to Auto, this feature is no supported. Integration state always becomes to "Error" after the recovery, and it does not continue the integration process.

Auto range Voltage and Current: Available (When the Data Update Interval is set to other than Auto.)

- Motor Inputs and Auxiliary Inputs: Not available
- When Element Independent is set to ON: Not available
- When S and Q Formula are set to Type 3: Not available

Accuracy ±(Normal measurement accuracy + 0.02% of reading)

Timer accuracy ±0.02% of reading

Harmonic Measurement (/G5, /G6 Option)	
Measured source	All installed elements
Method	PLL synchronization method (without external sampling clock function)
Frequency range	When the Data update interval is set to other than Auto, or when the Data update interval is set to Auto and FFT data length is set to 8192, Fundamental frequency of the PLL source is in the range of 0.5 Hz to 2.6 kHz. When the Data update interval is set to Auto and FFT data length is set to 1024, Fundamental frequency of the PLL source is in the range of 0.1 Hz to 2.6 kHz.
PLL source	<ul style="list-style-type: none"> Select the voltage or current of each input element or the external clock. If the /G6 option is selected and if the Data update interval is set to other than Auto, two PLL sources can be selected, and dual harmonic measurement can be performed. If the /G5 option is selected, one PLL source is selectable. Input level 15 V or more of range for voltage input. 50 mA or more of range for direct current input. 200 mV or more of range for external current sensor input. 50% or more of the measurement range rating for crest factor CF3. 100% or more of the measurement range rating for crest factor CF6/CF6A. 20 Hz to 1 kHz for the 1 A or 2 A range of the 50 A input element. The frequency filter ON condition is the same as with frequency measurement.
FFT data length	1024 when the data update rate is 50 ms, 100 ms, or 200 ms 8192 when the data update rate is 500 ms, 1 s, 2 s, 5 s, 10 s, or 20 s Select from 1024 or 8192 when the Data update interval is set to Auto
Window function	Rectangular
Anti-aliasing filter	Set using a line filter

Sample rate, window width, and upper limit of the measured order

1024 FFT points (data update interval 50 ms, 100 ms, 200 ms)

Fundamental frequency	Sampling rate	Window width	Upper limit of measured order	
			U, I, P, Q, QI	Other measured values
15 Hz to 600 Hz	f × 1024	1	500	100
600 Hz to 1200 Hz	f × 512	2	255	100
1200 Hz to 2600 Hz	f × 256	4	100	100

However, the maximum measured order is 100 at a date update rate of 50 ms.

8192 FFT points (data update interval 500 ms, 1 s, 2 s, 5 s, 10 s, 20 s)

Fundamental frequency	Sampling rate	Window width	Upper limit of measured order	
			U, I, P, Q, QI	Other measured values
0.5 Hz to 1.5 Hz	f × 8192	1	500	100
1.5 Hz to 5 Hz	f × 4096	2	500	100
5 Hz to 10 Hz	f × 2048	4	500	100
10 Hz to 600 Hz	f × 1024	8	500	100
600 Hz to 1200 Hz	f × 512	16	255	100
1200 Hz to 2600 Hz	f × 256	32	100	100

FFT points 1024 (Data update interval Auto)

Fundamental frequency	Sampling rate	Window width	Upper limit of measured order	
			U, I, P, f, fU, fI	Other measured values
0.1 Hz to 75 Hz	f × 1024	1	100	100
75 Hz to 600 Hz	f × 1024	1	100	100
600 Hz to 1200 Hz	f × 512	2	100	100
1200 Hz to 2600 Hz	f × 256	4	100	100

FFT points 8192 (Data update interval Auto)

Fundamental frequency	Sampling rate	Window width	Upper limit of measured order	
			U, I, P, f, fU, fI	Other measured values
0.5 Hz to 75 Hz	f × 1024	8	100	100
75 Hz to 600 Hz	f × 1024	8	100	100
600 Hz to 1200 Hz	f × 512	16	100	100
1200 Hz to 2600 Hz	f × 256	32	100	100

Accuracy

Add the following accuracy to the normal measurement accuracy.

- When the line filter is set to OFF and Update interval is set to other than Auto

Frequency	Voltage	Current	Power
0.5 Hz ≤ f < 10 Hz	±(0.05% of reading +0.25% of range)	±(0.05% of reading +0.25% of range)	±(0.1% of reading +0.5% of range)
10 Hz ≤ f < 45 Hz	±(0.05% of reading +0.25% of range)	±(0.05% of reading +0.25% of range)	±(0.1% of reading +0.5% of range)
45 Hz ≤ f ≤ 66 Hz	±(0.05% of reading +0.25% of range)	±(0.05% of reading +0.25% of range)	±(0.1% of reading +0.5% of range)
66 Hz < f ≤ 440 Hz	±(0.05% of reading +0.25% of range)	±(0.05% of reading +0.25% of range)	±(0.1% of reading +0.5% of range)
440 Hz < f ≤ 1 kHz	±(0.05% of reading +0.25% of range)	±(0.05% of reading +0.25% of range)	±(0.1% of reading +0.5% of range)
1 kHz < f ≤ 10 kHz	±(0.5% of reading +0.25% of range)	±(0.5% of reading +0.25% of range)	±(1% of reading +0.5% of range)
10 kHz < f ≤ 100 kHz	±0.5% of range	±0.5% of range	±1% of range
100 kHz < f ≤ 260 kHz	±1% of range	±1% of range	±2% of range

- When the line filter is set to OFF and update interval is set to Auto

Frequency	Voltage	Current	Power
0.1 Hz ≤ f < 10 Hz	±(0.05% of reading +0.25% of range)	±(0.05% of reading +0.25% of range)	±(0.1% of reading +0.5% of range)
10 Hz ≤ f < 45 Hz	±(0.05% of reading +0.25% of range)	±(0.05% of reading +0.25% of range)	±(0.1% of reading +0.5% of range)
45 Hz ≤ f ≤ 66 Hz	±(0.05% of reading +0.25% of range)	±(0.05% of reading +0.25% of range)	±(0.1% of reading +0.5% of range)
66 Hz < f ≤ 440 Hz	±(0.05% of reading +0.25% of range)	±(0.05% of reading +0.25% of range)	±(0.1% of reading +0.5% of range)
440 Hz < f ≤ 1 kHz	±(0.05% of reading +0.25% of range)	±(0.05% of reading +0.25% of range)	±(0.1% of reading +0.5% of range)
1 kHz < f ≤ 10 kHz	±(0.5% of reading +0.25% of range)	±(0.5% of range 0.25% of range)	±(1% of reading +0.5% of range)
10 kHz < f ≤ 100 kHz	±0.5% of range	±0.5% of range	±1% of range
100 kHz < f ≤ 260 kHz	±1% of range	±1% of range	±2% of range

- When the line filter is ON
 Add the accuracy of the line filter to the accuracy of when the line filter is OFF
 All the items below apply to any of the tables.

- When the Crest factor is set to CF3
- When λ (power factor) = 1
- Power figures that exceed 2.6 kHz are reference values.
- For the voltage range, add the following values.
 Voltage accuracy: ±25 mV
 Power accuracy: ±([25 mV/voltage range rating] × 100% of range)
- For the direct current input range, add the following values.
 5 A element
 Current accuracy: ±50 μA
 Power accuracy: ±([50 μA/current range rating] × 100% of range)
 50 A element
 Current accuracy: ±4 mA
 Power accuracy: ±([4 mA/current range rating] × 100% of range)
- For the external current sensor range, add the following values.
 Current accuracy: ±2 mV
 Power accuracy: ±([2 mV/external current sensor range rating] × 100% of range)
- Add ±([n/500]% of reading) to the nth component of the voltage and current, and add ±([n/250]% of reading) to the nth component of the power.
- Accuracy when the Crest factor CF6/CF6A
 Same as when the range is doubled for Crest factor CF3
- The guaranteed accuracy range by frequency and voltage/current is the same as the guaranteed range of normal measurement.
- The adjacent orders of the input order may be affected by the side rope.
- Under the condition of Data update interval is set to other than Auto, or Data update interval is set to Auto and PPL points is 8192,
 - For nth order component input when the PLL source frequency is 2 Hz or more, add ±([n/(m+1)]/50)% of (the nth order reading) to the (n+m)th order and (n-m)th order of the voltage and current, and add ±([n/(m+1)]/25)% of (the nth order reading) to the (n+m)th order and (n-m)th order of the power.
 - For nth order component input when the PLL source frequency is less than 2 Hz, add ±([n/(m+1)]/20)% of (the nth order reading) to the (n+m)th order and (n-m)th order of the voltage and current, and add ±([n/(m+1)]/10)% of (the nth order reading) to the (n+m)th order and (n-m)th order of the power.
- Under the condition of Data update interval is set to Auto and PPL points is 1024,
 - For nth order component input when the PLL source frequency is 75 Hz or more, add ±([n/(m+1)]/50)% of (the nth order reading) to the (n+m)th order and (n-m)th order of the voltage and current, and add ±([n/(m+1)]/25)% of (the nth order reading) to the (n+m)th order and (n-m)th order of the power.
 - For nth order component input when the PLL source frequency is less than 75 Hz, add ±([n/(m+1)]/10)% of (the nth order reading) to the (n+m)th order and (n-m)th order of the voltage and current, and add ±([n/(m+1)]/5)% of (the nth order reading) to the (n+m)th order and (n-m)th order of the power.

Motor Evaluation Function (/MTR Option)		
Input terminal	Torque, speed (A, B, Z)	
Input resistance	Approximately 1 MΩ	
Input connector type	Insulated BNC	
Analog Input (Speed is input to the A terminal)	Range	1 V, 2 V, 5 V, 10 V, 20 V
	Input range	±110%
	Line filter	OFF, 100, 1 kHz
	Continuous maximum allowable input	±22 V
	Maximum common mode voltage	±42 Vpeak
	Sampling rate	Approximately 200 kS/s
	Resolution	16-bit
	Accuracy	±(0.03% of reading + 0.03% of range)
	Temperature coefficient ±0.03% of range/°C	

Pulse Input (TORQUE, SPEED)	Speed is input to the A terminal if the direction is not detected. If the direction is detected, the A and B phases of the rotary encoder are input to the A and B terminals. The Z phase is input to the Z terminal of the rotary encoder for electric angle measurement.	
	Input range	±12 Vpeak
	Frequency measurement range	2 Hz to 1 MHz
	Maximum common mode voltage	±42 Vpeak
	Accuracy	±(0.03 + f/10000)% of reading ±1 mHz Accuracy of the waveform display data ±(0.03 + f/500)% of reading ±1 mHz The unit of f is kHz.
	Fall of the Z terminal input and electric angle measurement start time Within 500 ns	
	Detection level	H level: Approximately 2 V or more L level: Approximately 0.8 V or less
	Pulse width	500 ns or more
	Harmonic measurement option (/G5 or /G6) is required for electric angle measurement.	

Auxiliary Input (/AUX Option)	
Input terminal	AUX1/AUX2
Input type	Analog
Input resistance	Approximately 1 MΩ
Input connector type	Insulated BNC
Range	50 m, 100 m, 200 m, 500 m, 1, 2, 5, 10, 20 V
Input range	±110%
Line filter	OFF/100 Hz/1 kHz
Continuous maximum allowable input	±22 V
Common mode voltage	±42 Vpeak
Sampling rate	Approximately 200 kS/s
Resolution	16-bit
Accuracy	±(0.03% of reading + 0.03% of range) Add ±20 μV/°C to the change in temperature after zero level compensation or range change.
Temperature coefficient	±0.03% of range/°C

DA Output and Remote Control (/DA Option)	
DA Output	
D/A conversion resolution	16-bit
Output voltage	±5 V FS (maximum approximately ±7.5 V) relative to each rated value
Update rate	Same as the data update interval
Output	20 channels (Output parameter can be set for each channel)
Accuracy	±(Accuracy of each measurement function + 0.1% of FS) FS = 5 V
Minimum load	100 kΩ
Temperature coefficient	±0.05% of FS/°C
Continuous maximum common mode voltage	±42 Vpeak or less
Remote Control	
Signal	EXT START, EXT STOP, EXT RESET, INTEG BUSY, EXT HOLD, EXT SINGLE, EXT PRINT
Input level	0 to 5 V

Calculation and Event Function	
User-defined function	Compute the numerical data (up to 20 equations) with a combination of measurement function symbols and operators.
Efficiency calculation	Up to 4 efficiencies can be displayed by setting measurement parameters for the efficiency equations.
User-defined event	Event: Set conditions for measured values. The functions triggered by the event are Auto Print, Store, and DA Output.

High Speed Data Capturing Function	
Cycle of data capture	5 ms (When External Sync OFF) 1 ms to 100 ms (When External Sync ON, it synchronized with external signal from MEAS START terminal)
Data update rate	1 s (It displays the last numeric data during the 1 s period)
Meas. parameter	Voltage, Current, Power for each element and Σ* Torque and speed /Pm (/MTR), AUX1 and AUX2 (/AUX) *select voltage/current measurement mode from DC /RMS /MEAN /R-MEAN
Wiring	Single phase 2 wire (DC signal), Three phase 3 wire (3V3A), Three phase 4 wire
Line Filter	Always ON (Cut off frequency is 300 kHz and lower. 1 MHz cannot be selected.)
Data output	Internal RAM (approximately 30 MB), external USB storage PC through GP-IB, Ethernet of USB communication I/F (Every 1 s data block continuously)
Data measured time	1 to 10000000, or infinite
Data capturing start	Turn on START key of HS Setting menu Satisfy trigger conditions after received I/F command
Trigger	Mode: AUTO/NORMAL/OFF, Source: U1 to U6/I1 to I6/EXT, Slope: Rising edge/Falling Edge/both edges, Level: ±100.0%
HS filter	OFF, ON (Cut off: 1 Hz to 1000 Hz, 1 Hz unit setting)
Display	
Numerical Display	
Display digit (display resolution)	less than 60000: 5 digits 6000 or more: 4 digits
Number of display items	Select 4, 8, 16, Matrix, ALL, Harmonic Single List, Harmonic Dual List, and Custom
Waveform Display	
Display format	Peak-to-peak compression data If the time axis is set so that there will be insufficient sampling data, the part lacking data is filled with the preceding sampling data.
Sampling rate	Approximately 2 MS/s
Time axis	Range from 0.05 ms to 2 s/div. However, 1/10 or less of the data update interval when Data update interval is set to other than Auto. Range from 0.05 ms to 5 ms/div when the Data update interval is set to Auto.
Trigger	Trigger type Edge type Trigger mode Select OFF, Auto, and Normal. Automatically turned OFF during integration. Automatically OFF when the Data update interval is set to Auto. Trigger source Select voltage or current input to the input element or external clock Trigger slope Select Rise, Fall, or Rise/Fall Trigger Level Set the trigger level in the range of ±100% from the center of the screen (from top to bottom of the screen) if the trigger source is the voltage or current input to the input element. The set resolution is 0.1%. TTL level if the trigger source is Ext Clk (external clock).
Time axis zoom function	Not available

*Waveforms can be represented faithfully at up to approximately 100 kHz because the sampling rate is approximately 2 MS/s.

Data Store Function			
Store	Store numerical data in media. (Media: USB storage device, maximum 1 GB)		
Store interval	50 ms (when waveform display is OFF) to 99 hours 59 minutes 59 seconds		
Storage time when using 1 GB memory (Numerical Store and Waveform Display OFF)			
Number of measurement channels	Number of measurement items (each channel)	Storage interval	Storable time (Approximately)
3 ch	5	50 ms	5 days
3 ch	20	50 ms	56 hours
3 ch	Each harmonic component data of DC to the 100th order of voltage, current, and power	50 ms	4 hours
6 ch	5	1 s	86 days
6 ch	20	1 s	24 days
6 ch	Each harmonic component data of DC to the 100th order of voltage, current, and power	1 s	40 hours
6 ch	Each harmonic component data of DC to the 500th order of voltage, current, and power	100 ms	49 minutes

*One piece of data is 4 bytes, and the limit to the number of store operations is 9999999 counts.
*If the update interval is set to Auto the storable time might be shortened.

File Function	
Save	Save setting information, waveform display data, numerical data, and screen image data to media
Read	Read the saved setting information from media.

Auxiliary I/O	
I/O Section for Master/Slave Synchronization Signals	
Connector type	BNC connector: Applicable to both master and slave
I/O level	TTL: Applicable to both master and slave
Measurement start delay time	Within 15 sample intervals: Applicable to master Within 1 μ s + 15 sample intervals: Applicable to slave
External Clock Input	
Common	Connector type BNC connector Input level TTL
When a synchronization source for normal measurement is used as the external clock for input	Frequency range Same as the measurement range of frequency measurement. Input waveform Square waveform with a duty ratio of 50%
When a PLL source for harmonic measurement is used as the external clock for input	Frequency range Harmonic measurement (/G5 or /G6) option: 0.5 Hz to 2.6 kHz Input waveform Square waveform with a duty ratio of 50%
Trigger	Minimum pulse width 1 μ s Trigger delay time Within (1 μ s + 15 sample intervals)
RGB Output (Option)	Connector type D-sub 15-pin (receptacle) Output format Analog RGB output
Computer Interface	
GP-IB Interface	
Compatible devices	National Instruments <ul style="list-style-type: none"> • PCI-GPIB and PCI-GPIB+ • PCIe-GPIB and PCIe-GPIB+ • PCMCIA-GPIB and PCMCIA-GPIB+ • GPIB-USB-HS and GPIB-USB-HS+ Use an NI-488.2M Version 1.60 or later driver
Electrical and mechanical specifications	Conforms to the IEEE Standard 488-1978 (JIS C 1901-1987)
Functional specifications	SH1, AH1, T6, L4, SR1, RL1, PP0, DC1, DT1, C0
Protocol	Conforms to the IEEE Standard 488.2-1992
Encoding	ISO (ASCII)
Mode	Addressable mode
Address	0 to 30
Clearing remote mode	Remote mode can be cleared by pressing the LOCAL key (except during Local Lockout)
Ethernet Interface	
Number of communication ports	1
Connector type	RJ-45 connector
Electrical and mechanical specifications	Conforms to the IEEE802.3
Transmission method	Ethernet 1000BASE-T, 100BASE-TX, 10BASE-T
Communication protocol	TCP/IP
Applicable services	FTP server, DHCP, DNS, remote control (VXI-11), SNMP, FTP client, Modbus/TCP server, Web server
USB PC Interface	
Number of ports	1
Connector	Type B connector (receptacle)
Electrical and mechanical specifications	Conforms to the USB Revision 2.0
Applicable transfer standards	HS (High Speed) mode (480 Mbps), FS (Full Speed) mode (12 Mbps)
Applicable protocols	USBTMC-USB488 (USB Test and Measurement Class Version 1.0)
Applicable system environment	The PC must run the Japanese or English version of Windows XP/7/8/8.1/10, and be equipped with a USB port.
USB for Peripheral Devices	
Number of ports	2
Connector type	USB type A connector (receptacle)
Electrical and mechanical specifications	
Conforms to USB Revision 2.0	
Applicable transfer standards	
HS (High Speed) mode (480 Mbps), FS (Full Speed) mode (12 Mbps), LS (Low Speed) mode (1.5 Mbps)	
Applicable devices	
Mass storage device conforming to USB Mass Storage Class Version 1.1 Available space: 2 TB, Partition format: MBR, Format type: FAT32/FAT16 109 and 104 keyboards conforming to USB HID Class Version 1.1 Mouse conforming to USB HID Class Version 1.1	
Power supply	5 V, 500 mA (for each port). However, devices that exceed the maximum current consumption of 100 mA cannot be connected to two ports simultaneously.
Built-in Printer (/B5 Option)	
Printing method	Thermal line dot method
Dot density	8 dots/mm

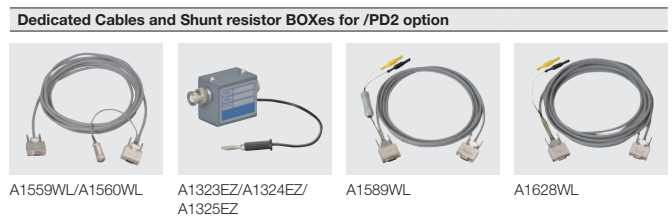
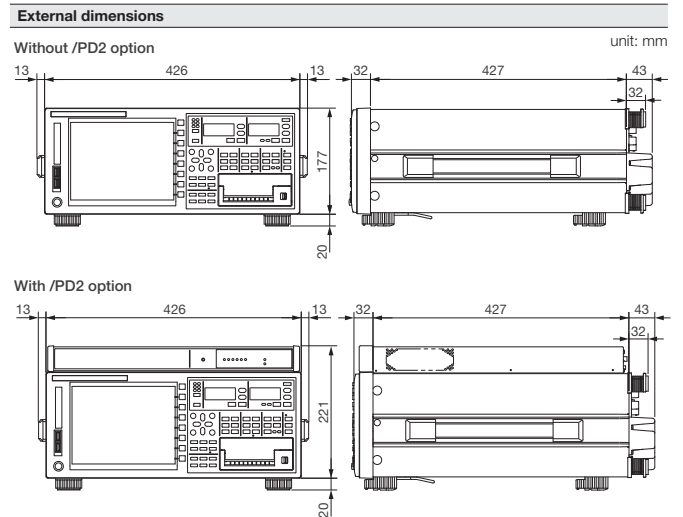

Paper width	80 mm
Effective recording width	72 mm
Auto Print	Allows you to set the interval time for printing to automatically print the measured values. The start/stop time can also be set.
Current Sensor Power (/PD2 Option)	
Number of channel	6
Connector type	D-sub9 pin (Plug)
Output voltage	\pm 15 V DC
Output current	1.8 A/1 channel
General Specifications	
Warm-up time	Approximately 30 minutes
Operation environment	Temperature: 5 to 40°C Humidity: 20 to 80%RH (no condensation)
Operating altitude	2000 m or less
Installation location	Indoors
Storage environment	Temperature: -25 to 60°C Humidity: 20 to 80%RH (no condensation)
Rated power supply voltage	100 to 240 VAC
Allowable power supply voltage fluctuation range	90 to 264 VAC
Rated power supply frequency	50/60 Hz
Allowable power supply frequency fluctuation range	48 to 63 Hz
Maximum power consumption	
150 VA (when using a built-in printer) 450 VA (when using a built-in printer and Current Sensor Power)	
Dimensions	Approximately 426 mm (W) \times 177 mm (H) \times 459 mm (D) (Excluding the handle and other projections when the printer is stored in the cover) Approximately 426 mm (W) \times 221 mm (H) \times 459 mm (D) (When the printer cover is not attached; Excluding the handle and other protruding parts; /PD2 option is mounted.)
Weight	Approximately 15 kg (including the main body, 6 input elements, and options without /PD2) About 17 kg (main body, 6 input elements, and options including /PD2 are mounted)
Battery backup	Setting information and built-in clock continue to operate with a lithium backup battery.
*Warning for Class A instruments	
This is a Class A instrument based on Emission standards EN61326-1 and EN55011, and is designed for an industrial environment. Operation of this equipment in a residential area may cause radio interference, in which case users will be responsible for any interference which they cause.	













*EX1 to /EX6 options must be installed in the WT1800E to be able to use of the Shunt Resistor Box.

Accessories

Related products

<p>AC/DC Current Sensor</p>  <p>CT60/CT200/CT1000/CT2000A</p> <p>AC/DC Current Sensors</p> <p>Current Output</p> <ul style="list-style-type: none"> DC to 800 kHz/60 Apeak, DC to 500 kHz/200 Apeak, DC to 300 kHz/1000 Apeak, DC to 40 kHz/2000 Arms (3000 Apeak) Wide dynamic range -2000 A to 0 A to +2000 A (DC)/2000 Arms (AC) Wide measurement frequency range: DC and up to 800 kHz High-precision fundamental accuracy: ±(0.05% of reading + 30 µA) ±15 V DC power supply, connector, and load resistor required. <p>For detailed information, see Current Sensors & Accessories Catalog Bulletin CT1000-00E.</p>	<p>Clamp on Probe</p>  <p>751552</p> <p>Current Clamp on Probe</p> <p>Current Output</p> <ul style="list-style-type: none"> AC 1000 Arms (1400 Apeak) Measurement frequency range: 30 Hz to 5 kHz Basic accuracy: ±0.3% of reading Maximum allowed input: AC 1000 Arms, maximum 1400 Apeak (AC) Current output type: 1 mA/A <p>A separately sold fork terminal adapter set (758921), measurement leads (758917), etc. are required for connection to WT3000E. For detailed information, see Power Meter Accessory Catalog Bulletin CT1000-00E.</p>	<p>Current Sensor Unit</p>  <p>751522, 751524</p> <p>Current Sensor Unit</p> <p>Current Output</p> <ul style="list-style-type: none"> DC to 100 kHz/1000 Apeak Wide dynamic range: -1000 A to 0 A to +1000 A (DC)/1000 Apeak (AC) Wide measurement frequency range: DC to 100 kHz (-3 dB) High-precision fundamental accuracy: ±(0.05% of reading + 40 µA) Superior noise withstanding ability and CMRR characteristic due to optimized casing design <p>751522/751524 do not conform to CE Marking For detailed information, see Power Meter Accessory Catalog Bulletin CT1000-00E.</p>
---	--	--

Adapters and Cables

 <p>758917</p> <p>Measurement leads</p> <p>Two leads in a set. Use 758917 in combination with 758922 or 758929. Total length: 75 cm. Rating: 1000 V, 32 A</p>	 <p>758922</p> <p>Small alligator adapters</p> <p>For connection to measurement leads (758917). Two in a set. Rating: 300 V</p>	 <p>758929</p> <p>Large alligator adapters</p> <p>For connection to measurement leads (758917). Two in a set. Rating: 1000 V</p>	 <p>758923*1</p> <p>Safety terminal adapter set (spring-hold type)</p> <p>Two adapters in a set.</p>	 <p>758931*1</p> <p>Safety terminal adapter set</p> <p>Screw-fastened adapters. Two adapters in a set. 1.5 mm Allen wrench included for tightening.</p>	 <p>758921</p> <p>Fork terminal adapter</p> <p>Two adapters (red and black) in a set. Used when attaching banana plug to binding post.</p>
 <p>758924</p> <p>Conversion adapter</p> <p>For conversion between male BNC and female banana plug</p>	 <p>366924/25*2</p> <p>BNC cable</p> <p>(BNC-BNC 1 m/2 m) For simultaneous measurements with 2 units or for an external trigger signal.</p>	 <p>B9284LK*3</p> <p>External Sensor Cable</p> <p>To connect the external input of the WT1800E to the current sensor. Length: 50 cm</p>	 <p>761902/03</p> <p>Safety BNC cable</p> <p>(BNC-BNC 1 m/2 m) To connect the Motor evaluation function to a torque sensor.</p>	<p>⚠ Due to the nature of this product, it is possible to touch its metal parts. Therefore, there is a risk of electric shock, so the product must be used with caution.</p> <p>*1 Maximum diameters of cables that can be connected to the adapters 758923 core diameter: 2.5 mm or less; sheath diameter: 4.8 mm or less 758931 core diameter: 1.8 mm or less; sheath diameter: 3.9 mm or less</p> <p>*2 Use with a low-voltage circuit (42 V or less)</p> <p>*3 The coax cable is simply cut on the current sensor side. Preparation by the user is required.</p>	

Typical Voltage/Current Connections

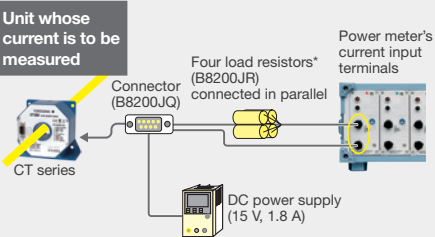
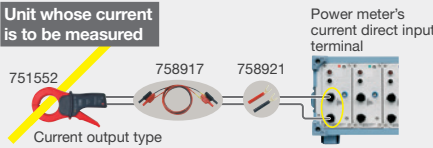
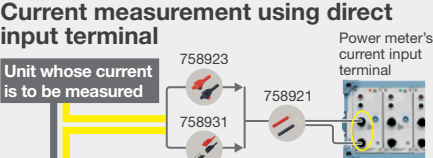
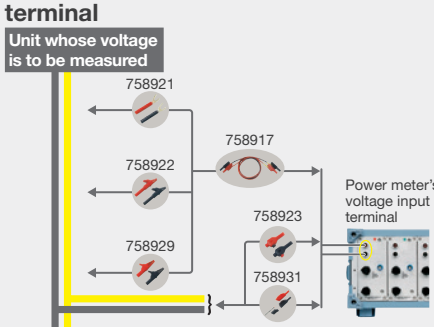
<p>Measurement using current sensor</p> <p>Connection example</p>  <p>Unit whose current is to be measured</p> <p>Power meter's current input terminals</p> <p>Four load resistors* (B8200JR) connected in parallel</p> <p>Connector (B8200JQ)</p> <p>CT series</p> <p>DC power supply (15 V, 1.8 A)</p>	<p>Measurement using clamp-on probe</p>  <p>Unit whose current is to be measured</p> <p>Power meter's current direct input terminal</p> <p>751552</p> <p>758917</p> <p>758921</p> <p>Current output type</p> <p>Current measurement using direct input terminal</p>  <p>Unit whose current is to be measured</p> <p>Power meter's current input terminal</p> <p>758923</p> <p>758931</p> <p>758921</p>	<p>Measurement using voltage input terminal</p>  <p>Unit whose voltage is to be measured</p> <p>Power meter's voltage input terminal</p> <p>758921</p> <p>758917</p> <p>758922</p> <p>758923</p> <p>758929</p> <p>758931</p>
--	--	--

*A burden resistor is required for the CT1000, CT200 and CT60.

Model and Suffix code

Precision Power Analyzer





Model	Suffix Code	Description
One input element model		
WT1801E	-5A0-50A1	50 A × 1 Input Element
	-5A1-50A0	5 A × 1 Input Element
Two input elements model		
WT1802E	-5A0-50A2	50 A × 2 Input Elements
	-5A1-50A1	5 A × 1 Input Element 50 A × 1 Input Element
	-5A2-50A0	5 A × 2 Input Elements
Three input elements model		
WT1803E	-5A0-50A3	50 A × 3 Input Elements
	-5A1-50A2	5 A × 1 Input Element 50 A × 2 Input Elements
	-5A2-50A1	5 A × 2 Input Elements 50 A × 1 Input Element
	-5A3-50A0	5 A × 3 Input Elements
Four input elements model		
WT1804E	-5A0-50A4	50 A × 4 Input Elements
	-5A1-50A3	5 A × 1 Input Element 50 A × 3 Input Elements
	-5A2-50A2	5 A × 2 Input Elements 50 A × 2 Input Elements
	-5A3-50A1	5 A × 3 Input Elements 50 A × 1 Input Element
	-5A4-50A0	5 A × 4 Input Elements
Five input elements model		
WT1805E	-5A0-50A5	50 A × 5 Input Elements
	-5A1-50A4	5 A × 1 Input Element 50 A × 4 Input Elements
	-5A2-50A3	5 A × 2 Input Elements 50 A × 3 Input Elements
	-5A3-50A2	5 A × 3 Input Elements 50 A × 2 Input Elements
	-5A4-50A1	5 A × 4 Input Elements 50 A × 1 Input Element
	-5A5-50A0	5 A × 5 Input Elements
Six input elements model		
WT1806E	-5A0-50A6	50 A × 6 Input Elements
	-5A1-50A5	5 A × 1 Input Element 50 A × 5 Input Elements
	-5A2-50A4	5 A × 2 Input Elements 50 A × 4 Input Elements
	-5A3-50A3	5 A × 3 Input Elements 50 A × 3 Input Elements
	-5A4-50A2	5 A × 4 Input Elements 50 A × 2 Input Elements
	-5A5-50A1	5 A × 5 Input Elements 50 A × 1 Input Element
	-5A6-50A0	5 A × 6 Input Elements
Standard Options		
Menu Language		
	-HC	Chinese/English
	-HE	English/Japanese
	-HG	German/English
	-HR	Russian/English
Power Cord		
	-D	UL/CSA Standard PSE compliant
	-F	VDE Standard
	-H	GB Standard
	-N	NBR Standard
	-Q	BS Standard
	-R	AS Standard
Additional Options		
Option		
	/EX1 ^{*1}	External Current Sensor Input for WT1801E
	/EX2 ^{*1}	External Current Sensor Input for WT1802E
	/EX3 ^{*1}	External Current Sensor Input for WT1803E
	/EX4 ^{*1}	External Current Sensor Input for WT1804E
	/EX5 ^{*1}	External Current Sensor Input for WT1805E
	/EX6 ^{*1}	External Current Sensor Input for WT1806E
	/B5	Built-in Printer
	/G5 ^{*2}	Harmonic Measurement
	/G6 ^{*2}	Simultaneous Dual Harmonics (except for WT1801E)
	/V1	RGB Output
	/DA	20-Channel D/A Output
	/MTR ^{*3}	Motor Evaluation Function
	/AUX ^{*3}	2-Channel Auxiliary Input
	/PD2 ^{*4}	6-Channel Current Sensor Power

*1, *4: When use Shunt Resistor Box for measurement, both /EX1 to /EX6 and /PD2 options are required. *2, *3: When select these functions, please specify only one. *4: /PD2 option requires Firmware version Ver. 3.1 or later.

Standard accessories

Power cord, Rubber feet, current input protective cover, User's manual, expanded user's manual, communication interface user's manual, printer roll paper (provided only with /B5), connector (provided only with /DA), Safety terminal adapter 758931 (provided two adapters in a set times input element number)
User's manuals [Start guide (booklet), function/operation, communication manuals (electronic file)]

Accessory (sold separately)

Model number	Product	Description
366924	 BNC-BNC Cable	1 m
366925	 BNC-BNC Cable	2 m
701901	1:1 Safety BNC Adapter Lead	1000 Vrms-CAT II for /MTR, /AUX
701902	Safety BNC-BNC Cable	1000 Vrms-CAT II, 1 m for /MTR, /AUX
701903	Safety BNC-BNC Cable	1000 Vrms-CAT II, 2 m for /MTR, /AUX
751535-E4	Rack Mounting Kit	For EIA without /PD2 option model
751535-J4	Rack Mounting Kit	For JIS without /PD2 option model
751535-E5	Rack Mounting Kit	For EIA with /PD2 option model
751535-J5	Rack Mounting Kit	For JIS with /PD2 option model
758917	Test Lead Set	A set of 0.75 m long, red and black test leads
758921	 Fork Terminal Adapter	Banana-fork adapter, Two adapters to a set
758922	 Small Alligator-clip	Rated at 300 V two in a set
758923	Safety Terminal Adapter	Two adapters to a set (spring-hold type)
758924	Conversion Adapter	BNC-banana-Jack (female) adapter
758929	 Large Alligator-clip	Rated at 1000 V and used in a pair
758931	Safety Terminal Adapter	Two adapters to a set (Screw-fastened type), 1.5 mm hex Wrench is attached.
CT60	AC/DC Current Sensor	Maximum 60 Apeak, DC to 800 kHz (-3 dB)
CT200	AC/DC Current Sensor	Maximum 200 Apeak, DC to 500 kHz (-3 dB)
CT1000	AC/DC Current Sensor	Maximum 1000 Apeak, DC to 300 kHz (-3 dB)
CT2000A	AC/DC Current Sensor	Maximum 2000 Arms, DC to 40 kHz (-3 dB)

Parts number	Product	Description	Order Q'ty
A1323EZ ^{*2}	Shunt Resistor Box	5 Ω ±0.05%	1
A1324EZ ^{*2}	Shunt Resistor Box	10 Ω ±0.02%	1
A1325EZ ^{*2}	Shunt Resistor Box	20 Ω ±0.02%	1
A1559WL	Current Sensor Cable	Cable length 3 m for Shunt Resistor Box	1
A1560WL	Current Sensor Cable	Cable length 5 m for Shunt Resistor Box	1
A1589WL	Current Sensor Direct Cable	Cable length 3 m (Burden resistor 2.7 Ω)	1
A1628WL	Current Sensor Direct Cable	Cable length 5 m (Without Burden resistor)	1
B9284LK 	External Sensor Cable	Current sensor input connector, Length 0.5 m	1
B9316FX	Printer Roll Paper	Thermal paper, 10 m (1 roll)	10

 Due to the nature of this product, it is possible to touch its metal parts. Therefore, there is a risk of electric shock, so the product must be used with caution.

*1: Use these products with low-voltage circuits (42 V or less).

*2: /EX option must be installed in the WT1800E to be able to use the Shunt Resistor Box.

■ Any company's names and product names mentioned in this document are trade names, trademarks or registered trademarks of their respective companies.

NOTICE

- Before operating the product, read the user's manual thoroughly for proper and safe operation.

Yokogawa's Approach to Preserving the Global Environment

- Yokogawa's electrical products are developed and produced in facilities that have received ISO14001 approval.
- In order to protect the global environment, Yokogawa's electrical products are designed in accordance with Yokogawa's Environmentally Friendly Product Design Guidelines and Product Design Assessment Criteria.

This is a Class A instrument based on Emission standards EN61326-1 and EN55011 and is designed for an industrial environment.
Operation of this equipment in a residential area may cause radio interference, in which case users will be responsible for any interference which they cause.

YOKOGAWA

YOKOGAWA TEST & MEASUREMENT CORPORATION

Global Sales Dept. /Phone: +81-422-52-6237 E-mail: tm@cs.jp.yokogawa.com
Facsimile: +81-422-52-6462

YOKOGAWA CORPORATION OF AMERICA

YOKOGAWA EUROPE B.V.

YOKOGAWA SHANGHAI TRADING CO., LTD.

YOKOGAWA ELECTRIC KOREA CO., LTD.

YOKOGAWA ENGINEERING ASIA PTE. LTD.

YOKOGAWA INDIA LTD.

YOKOGAWA ELECTRIC CIS LTD.

YOKOGAWA AMERICA DO SUL LTDA.

YOKOGAWA MIDDLE EAST & AFRICA B.S.C(c)

Phone: +31-88-4641000
Phone: +86-21-6239-6363
Phone: +82-2-2628-3810
Phone: +65-6241-9933
Phone: +91-80-4158-6396
Phone: +7-495-737-78-68
Phone: +55-11-5681-2400
Phone: +973-17-358100

E-mail: tmi@us.yokogawa.com
E-mail: tmi@nl.yokogawa.com
E-mail: tech@ysh.com.cn
E-mail: TMI@kr.yokogawa.com
E-mail: TMI@sg.yokogawa.com
E-mail: tmi@in.yokogawa.com
E-mail: info@ru.yokogawa.com
E-mail: help.ymatmi@bh.yokogawa.com

Facsimile: +86-21-6880-4987
Facsimile: +82-2-2628-3899
Facsimile: +65-6241-9919
Facsimile: +91-80-2852-1442
Facsimile: +7-495-737-78-69

Facsimile: +973-17-336100

<http://tmi.yokogawa.com/>

YMI-KS-MI-SE05

Subject to Change without notice.

Copyright © 2016, Yokogawa Test & Measurement Corporation

[Ed: 03/b]

Printed in Japan, 803(KP)